

 **MITSUBISHI**
HEAVY INDUSTRIES
AIR CONDITIONERS

HEAVY DUTY



HYBRID+
 AIRCONDITIONER

HYPER
 INVERTER

Next
 Generation
 High
 Performance
 Airconditioning

MOVE THE WORLD FORWARD ▶



Established Since - 1884

MOVE THE WORLD FORWARD

At Mitsubishi Heavy Industries Group, we bring people, businesses and ideas as one, to pave the way to a future of shared success. Utilizing our proven, forward-thinking approach and deep industry knowledge, we offer world-class innovative and integrated solutions across a wide range of industries and technologies, from planning to execution. Passionately seeking new, simpler and sustainable ways, we work with our clients and partners around the globe to create a better future for everyone who shares our planet.



Harmonizing People and technology on a global scale

As a global manufacturer, the fields in which Mitsubishi Heavy Industries work, knows no limits, offering more than 700 products that fall in all sectors and meet different needs and lifestyles, with the aim of reconciling public needs and technological innovation. With its eyes on the future, MHI will continue to traverse uncharted lands.



Our Vision > Your Future

Vision for a Global Perspective

"Our determination to conduct business on a global scale is supported by, and reflected in, a fundamental philosophy: utilization of inherent business acumen & technological expertise accumulated over more than 40 years to assess changes that occur with the passage of time while continuously developing previously unexplored areas.

Company Philosophy

We firmly believe that simple & direct method of operation brings about confidence in doing business more cohesively which strengthens our relation with our Dealers, our Channel partners in growth. Our increased involvement & deep collaboration with our Channel Partners makes the business simpler."

IAPL Group with its nationwide network has supported a wide array of projects including residential & large commercial establishment, Offices, Business establishments, Hotels, Hospitals, Schools, Commercial Complexes, Industries, etc. We have participated in projects for large Air Conditioning Systems requiring SYSTEM INTEGRATION of imported air conditioning equipment as per the international standards lay down by our principal- M/s. Mitsubishi Heavy Industries Ltd. We ensure much superior quality of workmanship with advanced engineering skills. We have full-fledged team of qualified engineers and technical staff in the air-conditioning divisions to meet all kind of requirements. IAPL has consistently provided Channel Partners with timely and high value service, competitively priced products without sacrificing quality.

HYBRID AC gives 1.5 times bigger area coverage compared to Conventional AC & still gives electricity saving upto 47%*



AREA COVERAGE TABLE

MODEL NO.	CAPACITY	AREA COVERAGE
SRK 13 CRS-S6	1.1 Ton	Upto 15.97 sq.mtr.***
SRK 15 CXS-W6	1.3 Ton	Upto 17.18 sq.mtr.***
SRK 20CXS-W6	1.6 Ton	Upto 23.23 sq.mtr.***
SRK 20 CSS-S6/A	1.6 [#] Ton # As per BEE its 1.69 ton	Upto 26.01 sq.mtr.***
SRK 24 CW-S6	1.95 Ton	Upto 32.5 sq.mtr.***
SRK 25 CWX-S6	1.95 Ton	Upto 37.17 sq.mtr.***
SRK 25 CSS-S6/A	2.2 Ton	Upto 41.80 sq.mtr.***

* Under Standard Installation & Lab Test Condition
As per BEE its 1.69 ton



HIGH CAPACITY MACHINES

We have designed the machines using higher capacity compressor + Bigger condenser Unit for maximum heat rejection for better cooling & higher energy efficiency, there by we claim for Maximum Cooling Capacities.

Outdoor Temperature



CAPACITY	MAXIMUM COOLING CAPACITY
1.1 Ton	13500 BTU/hr.
1.6 Ton	21000 BTU/hr.
2.2 Ton	26272 BTU/hr.



*** Customers need to seek guidance from the Authorized Dealer / Expert for the AC unit capacity selection before ordering any AC unit. Area coverage is subject to checking of the site conditions like - Terrace / Wall / Glass windows exposed to direct sunlight, of the area to be Air- conditioned & room temperature requirement & outdoor temperature conditions. Company will not be responsible if there will be cooling issues due to improper selection of capacity of the AC units.

3D Air Flow

3D AIR VERTICAL + HORIZONTAL AIR SCROLL
3 MOTORS MAKE 3 INDEPENDENT CONTROLS

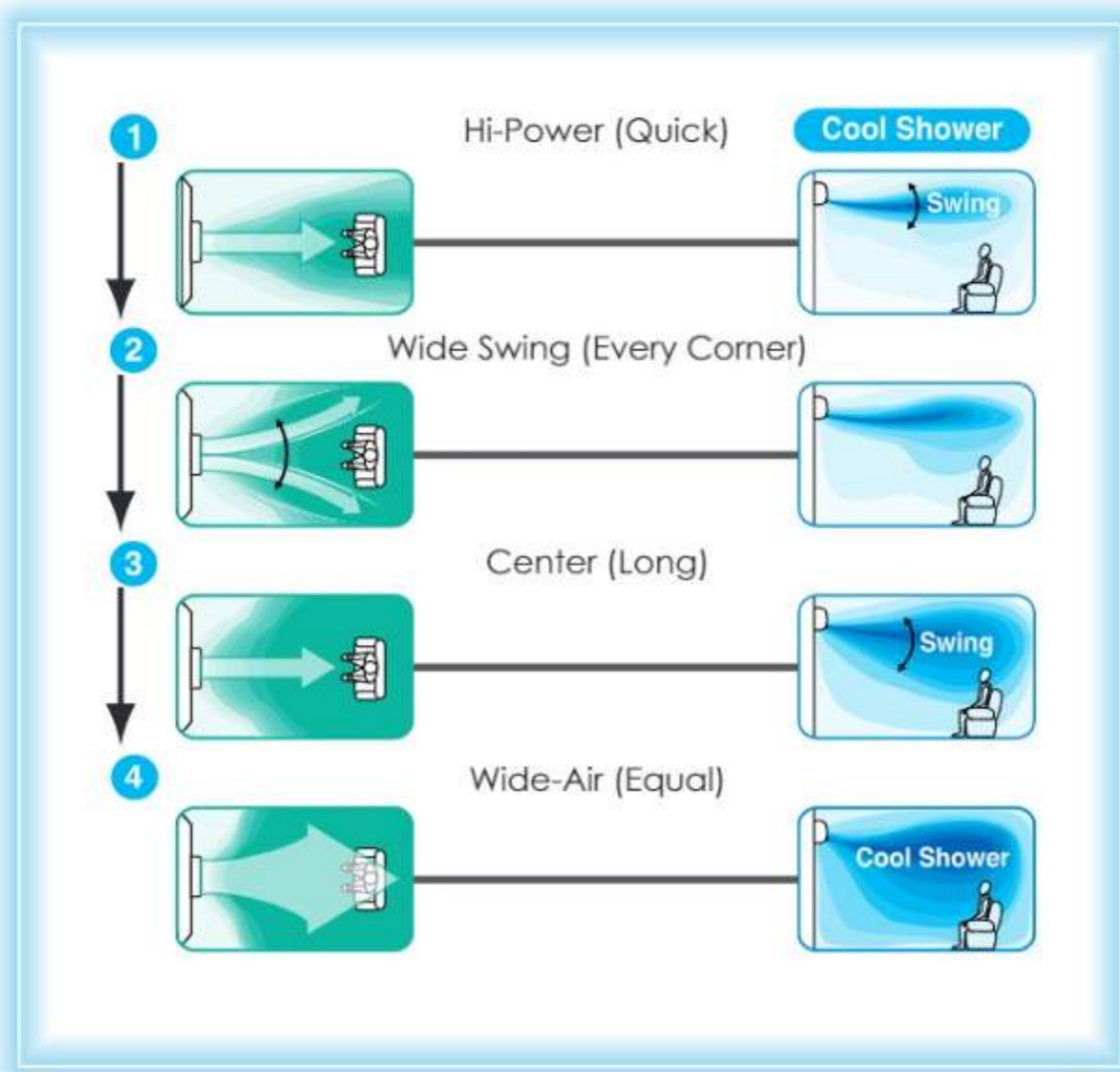

AUTO SETTING (3D AUTO)



Thanks to automatic control of air flow volume and air flow direction, comfortable air conditioning of the entire room can be done effectively.

In cooling operation cooled air flows directly to the ceiling. The cooled air does not flow directly to the occupants of the room and the comfort cooled air flow comes from the ceiling like a soft shower.

In heating operation warm air flows to the floor directly and spreads along the floor. Due to concentration of the warm air on the floor level, optimum comfort can be achieved.

MANUAL SETTING

By individual control of right and left part of louver, air flow direction from the right part and the left part are controlled individually. Setting the most preferable air flow direction and determining whether direct air flow is required or not at the same time minimizing of energy loss and economical operation has realized.



SURROUND COOLING

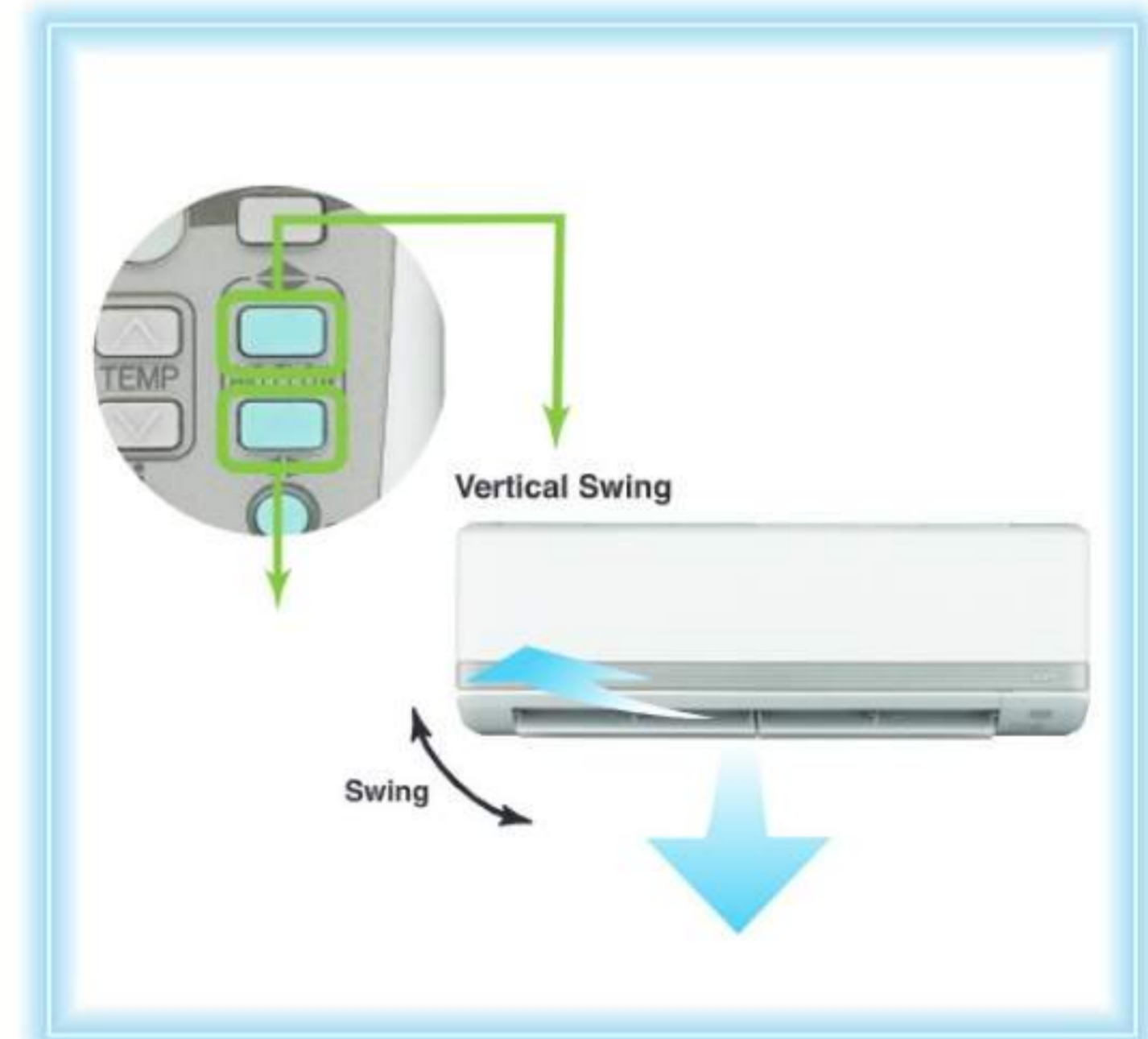

Horizontal Air Scroll 8 Direction Swing

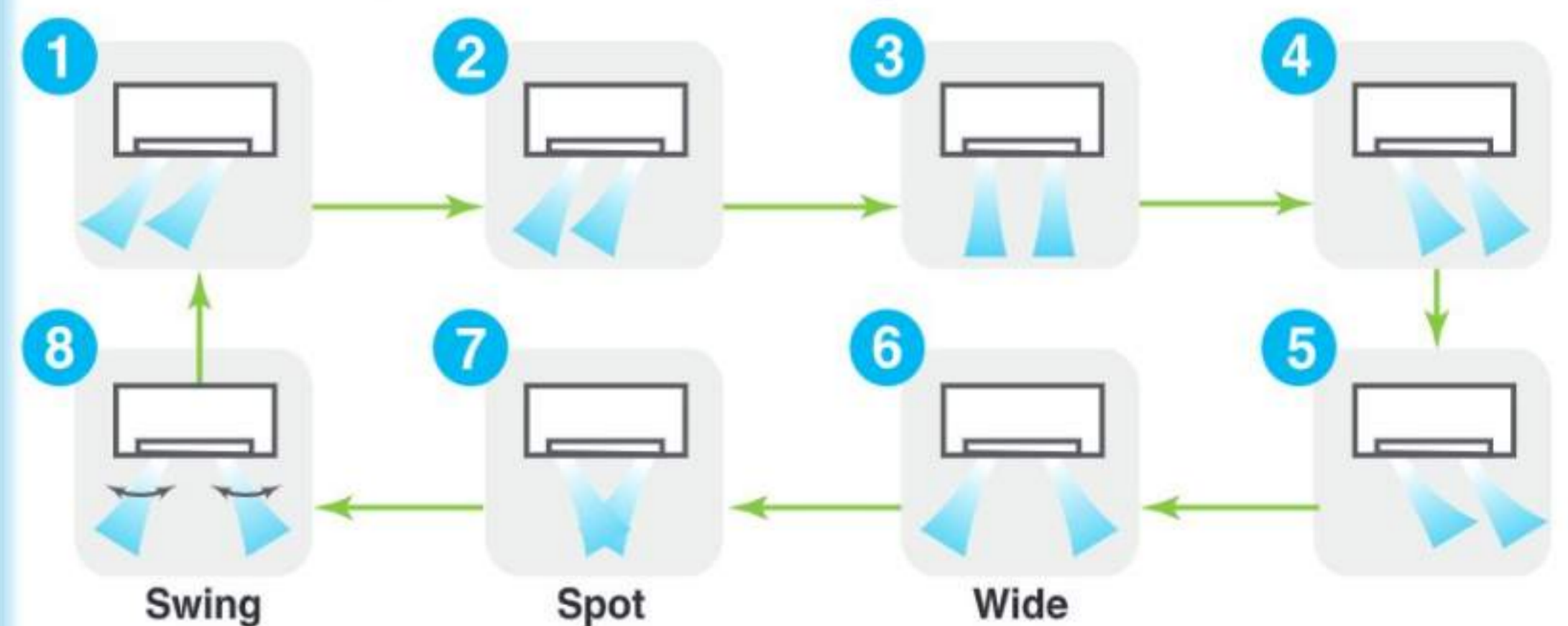

3D AUTO is one touch programmed and three motors (one vertical working motor + two horizontal working motors) make three independent air flow controls. The air flow is uniform and quiet and reaches at long distance points from the blower.

JET FLOW TECHNOLOGY

POWERFUL & SILENT AIR FLOW

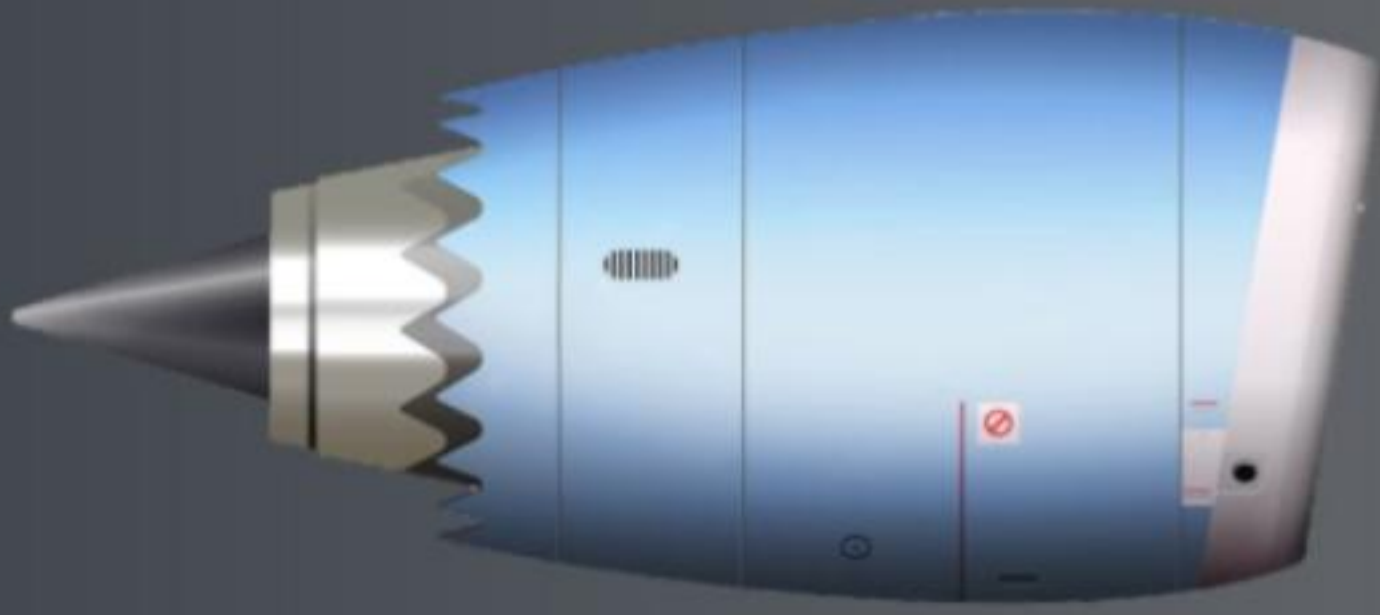

JET ENGINE TECHNOLOGY

CFD (computational fluid dynamics), used in blade shape design of jet engines, has been applied to the design of air channels in air conditioners to develop the ideal air channel system (air circulation). The air flow of the jets created in this system enable a large volume of air to be blown with minimum power consumption, yet the air flow is uniform, quiet and reaches points a long distance from the blower.

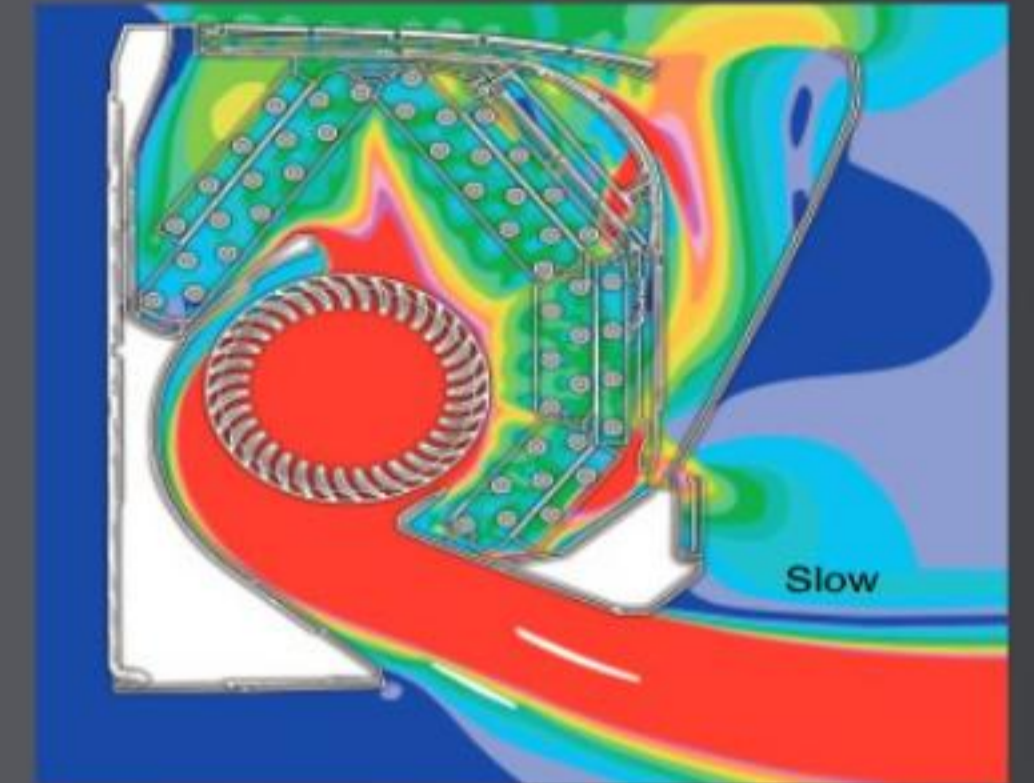

Fast ← → Slow
Colors in the figure show the air speed.

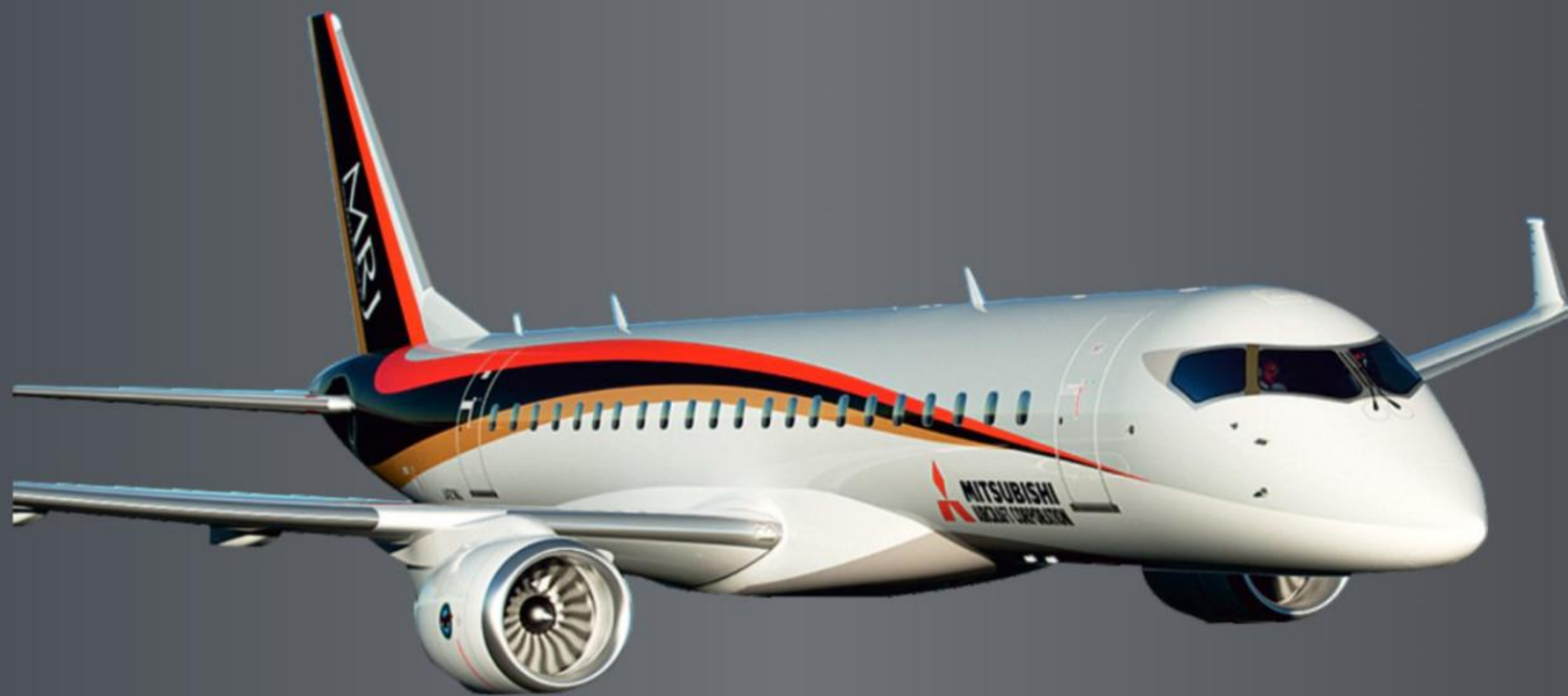

POSITIONING OF INSTALLATION

You can set the left-right air flow directions when you install the air conditioner near the side wall by remote controller operation.



NEW LOUVER

Due to redesigned size and shape, the new louver has been increased in surface area by 80%. In addition to increase of air flow volume, it has improved controllability of swinging to right and left.

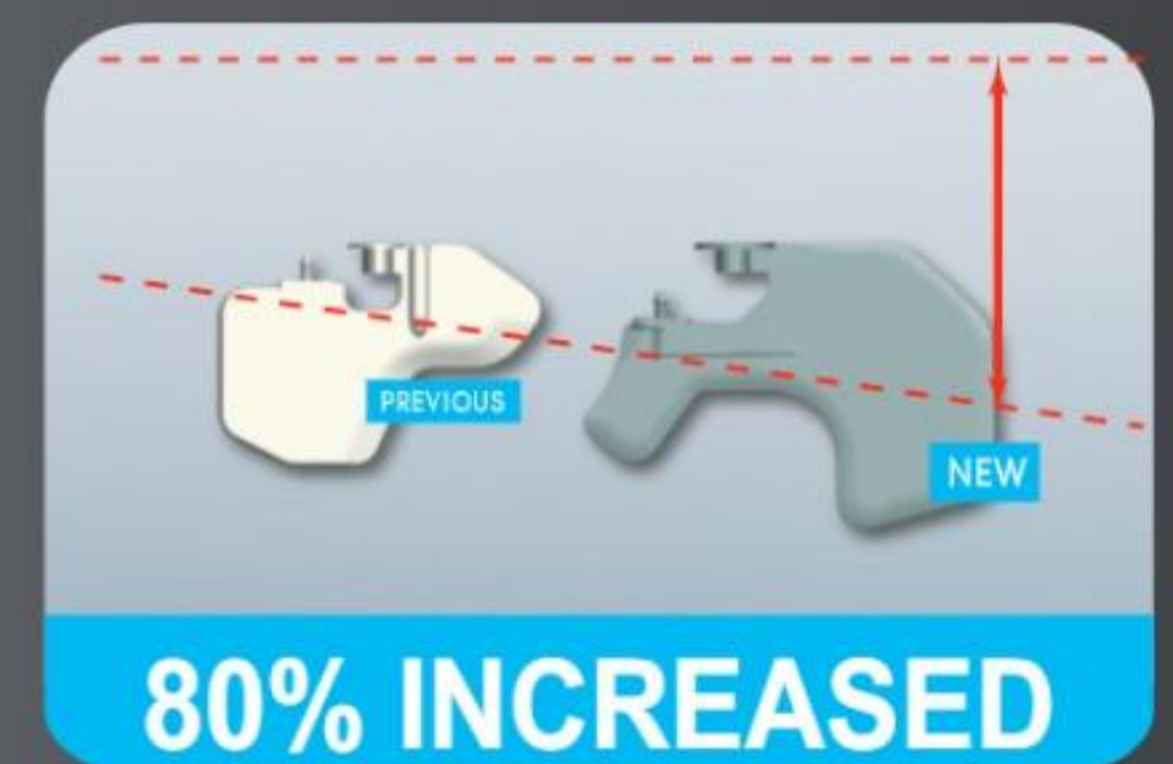

LONG REACH AIR FLOW

Powerful air flow is realized by Jet technology. Good for large living rooms and shops. Increase your comfort.

** Under Standard Installation & Lab Test Condition

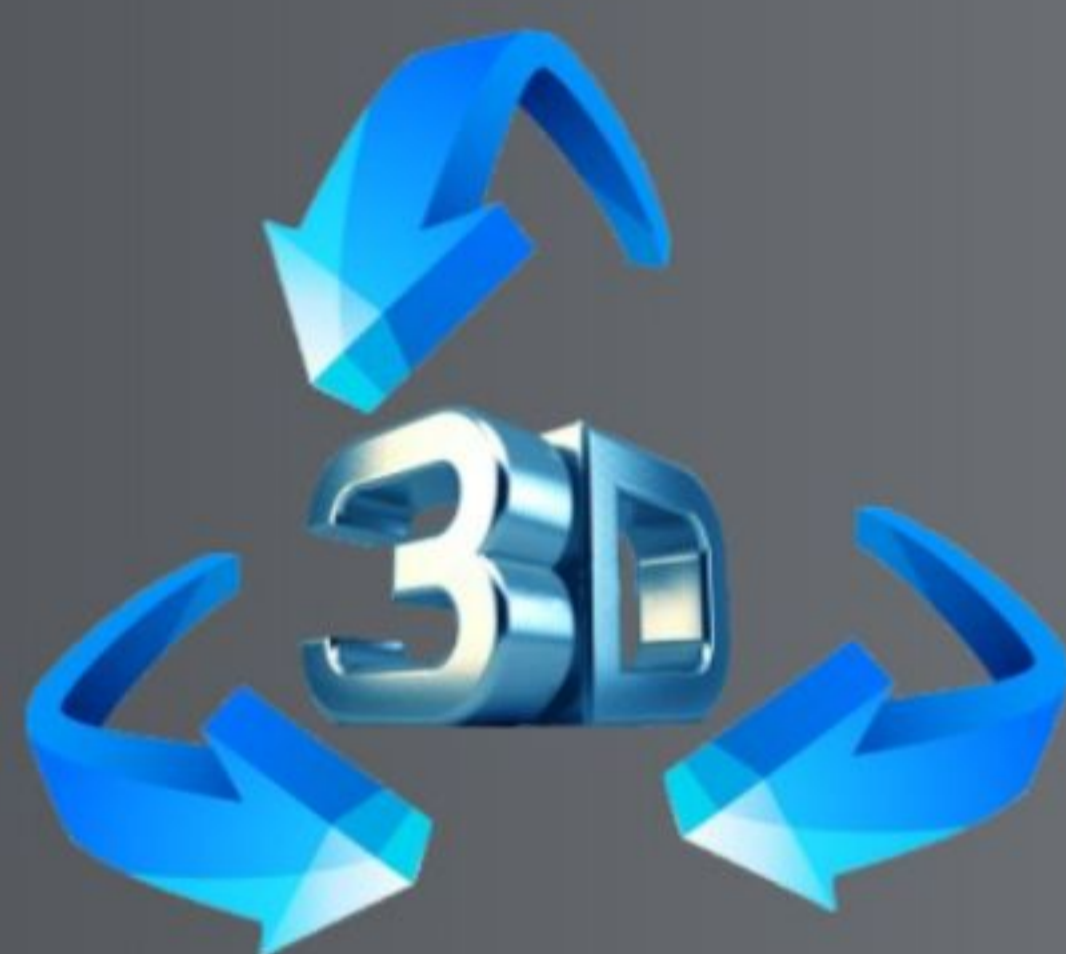
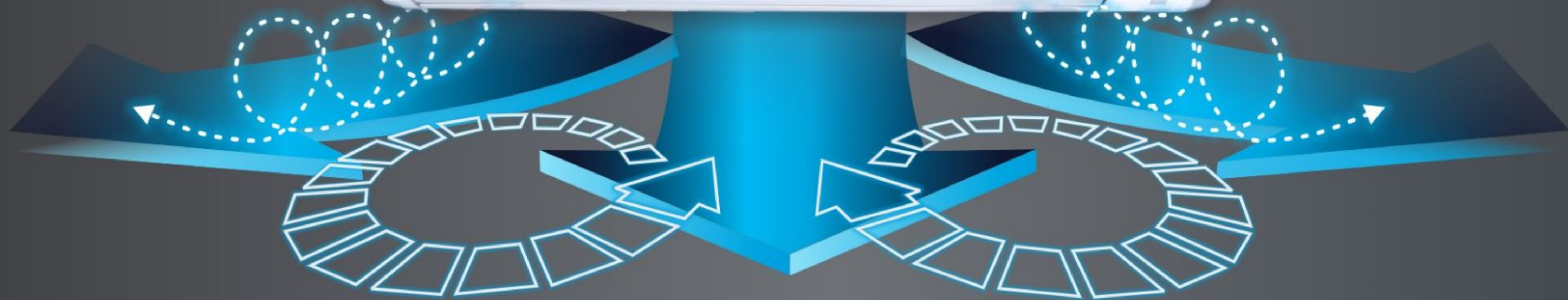
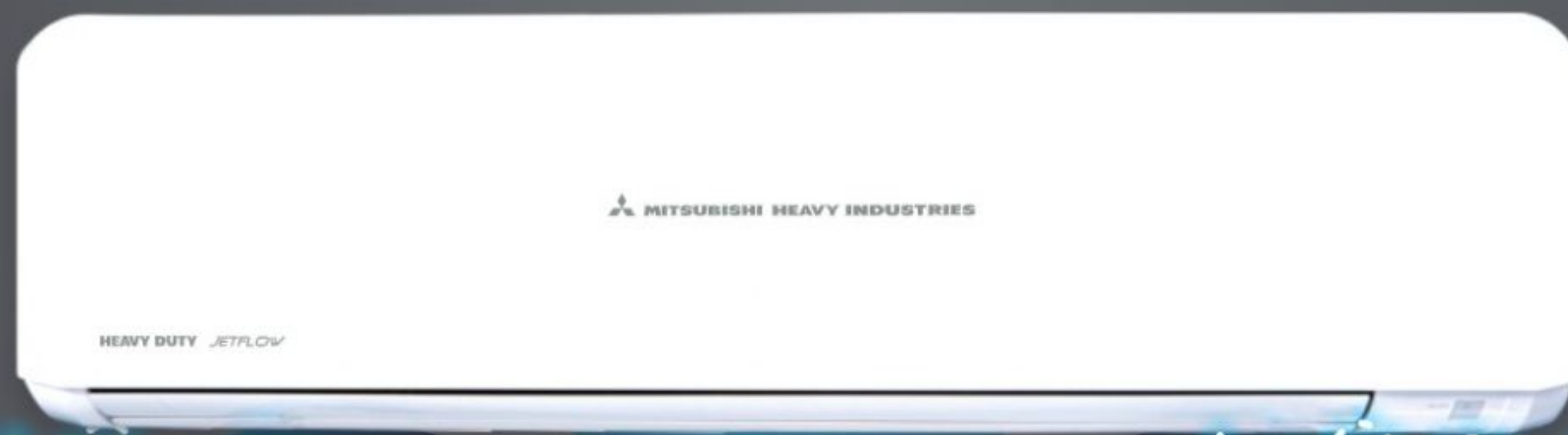

SURROUND COOLING

Silent Operation
Indoor Unit
(Hyper Inverter Series)



19dB

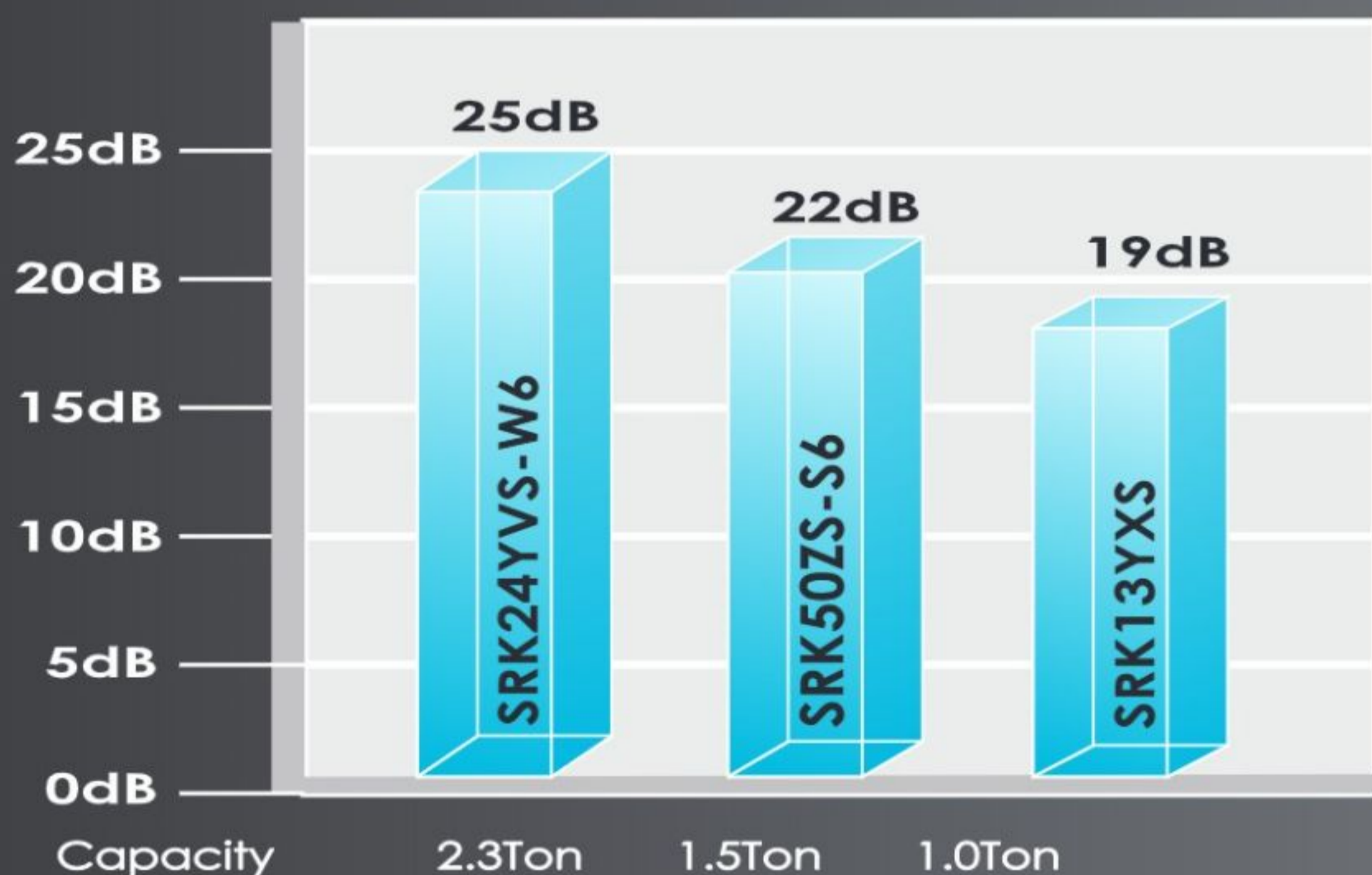

High Power Operation

In a cooling operation

This operation mode delivers powerful cool air to cool the room quickly. It blows powerful cool air when you want to be cooled down after bathing or returning home on a hot summer day so that you can enjoy a cool sensation immediately. The air conditioner automatically returns to the previous operation mode in 15 minutes to prevent the room from being cooled excessively.

SRK24YVS-W6 (2.2 Ton) -> 18.28 Meter**

SRK25CSS-S6/A → 18.2 mtr** / SRK20CSS-S6/A → 17 mtr**
(2.2 Ton) (1.6 Ton)

CLEAN AIR

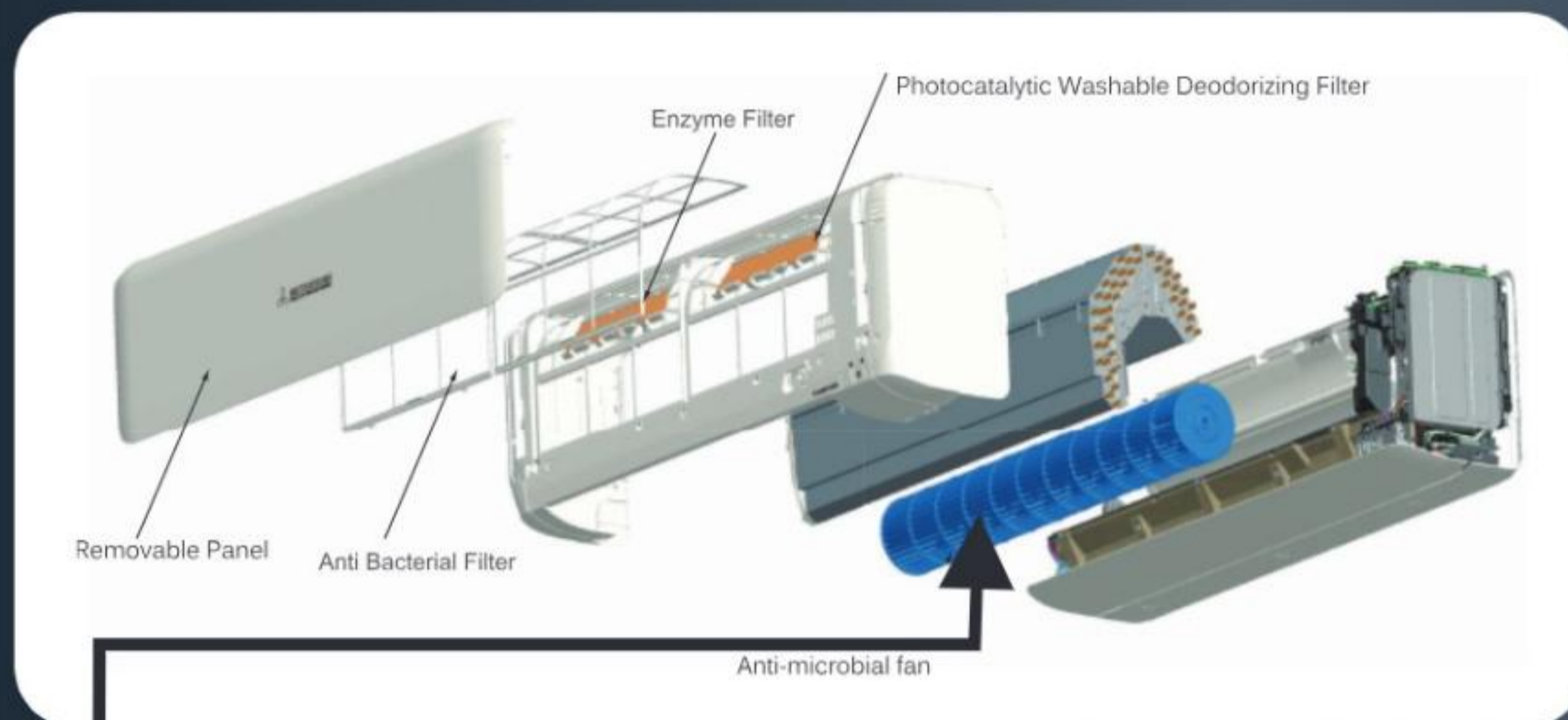

ANTI-MICROBIAL FAN



FOR GERM FREE AIR
ANTI - MOULD
ANTI - BACTERIAL

ALLERGEN CLEAR OPERATION

(Available only in : SRK13YXS-W6, SRK13YYM-W6, SRK18YYM-W6, SRK24YYM-W6, SRK18YXS2-W6, SRK50ZS-S6)

This can be activated by pressing the "allergen" button on the remote control and lasts 90 minutes before stopping automatically. It neutralizes all the bacteria collected on the surface of the anti-allergenic filter thanks to its sophisticated interaction between temperature and humidity controls.



Catching Allergen on the Filter

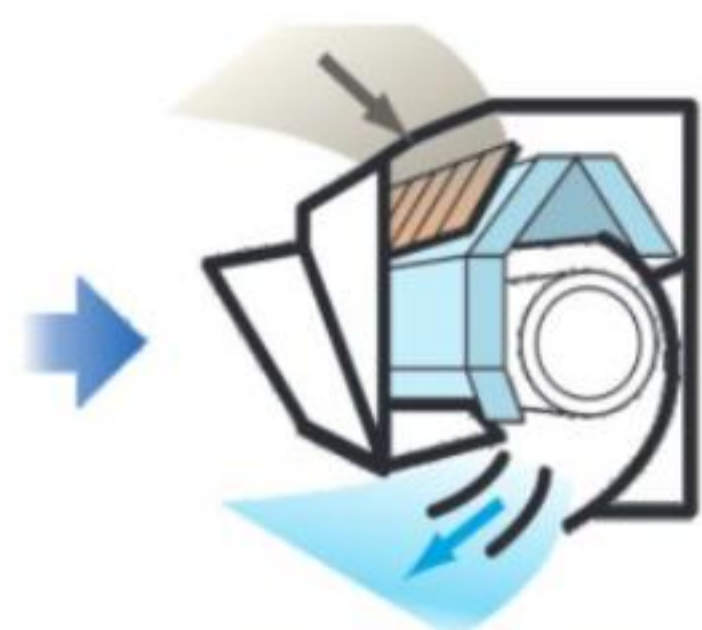

Cooling Operation
To make condensing water.



Heating Operation
To give moisture to the Filter to inactivate allergen



Self-Clean Operation
To dry up the indoor unit



SELF CLEAN OPERATION



Self Clean Operation" is operated for 2 hours after the unit has stopped its normal operation. The indoor unit is dried up and the growth of mold is restrained. Users can select whether this mode is utilized or not.

Always Keeping Indoor Unit Clean

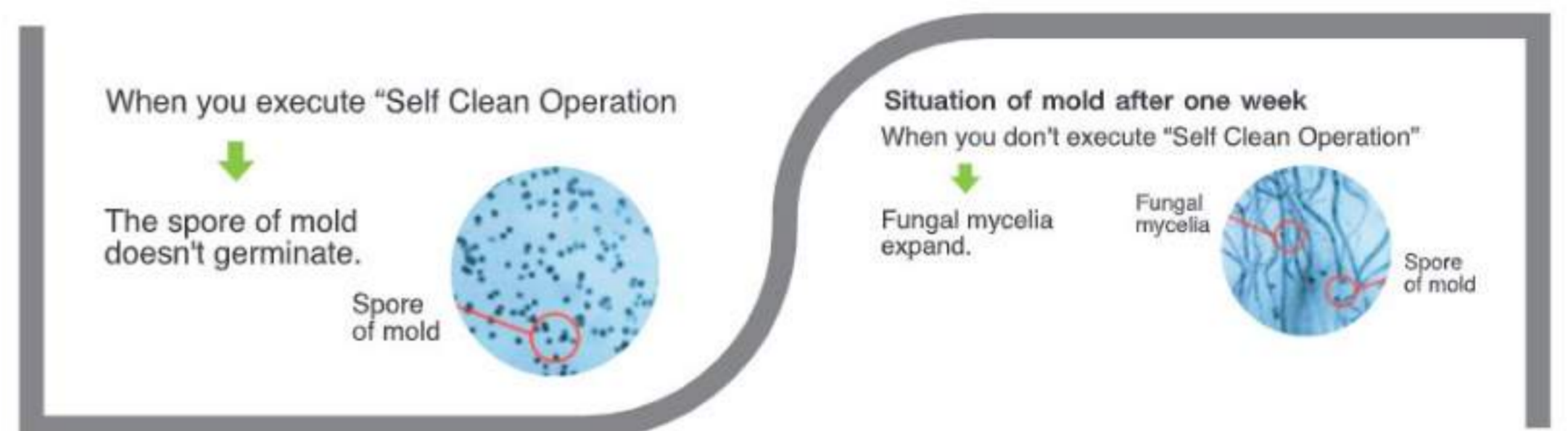
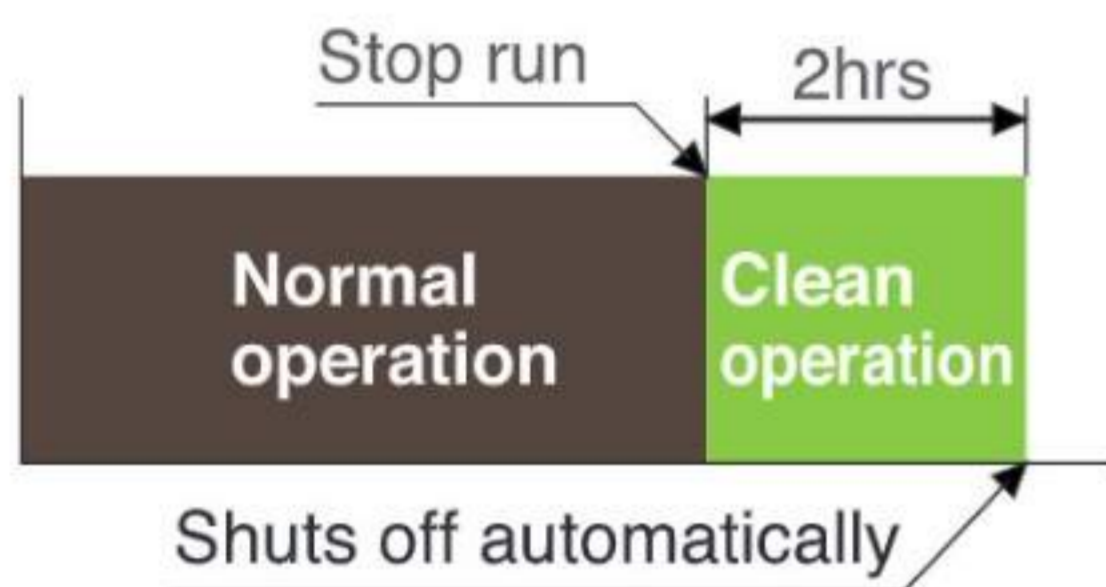

ENZYME FILTER

First in the world

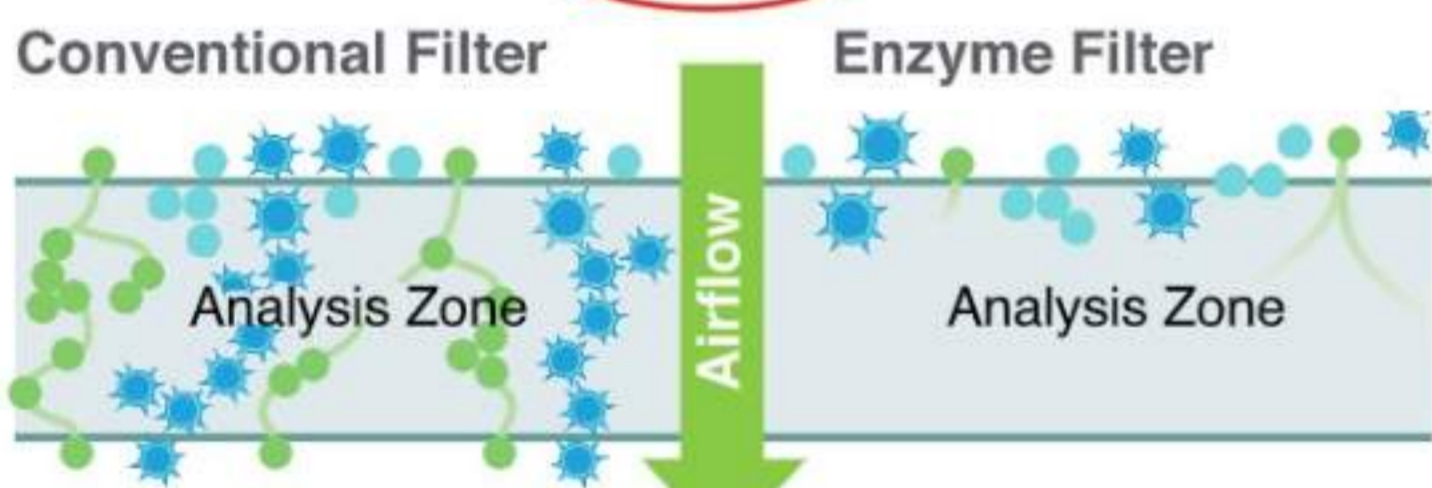

Enzyme's sterilizing mechanism

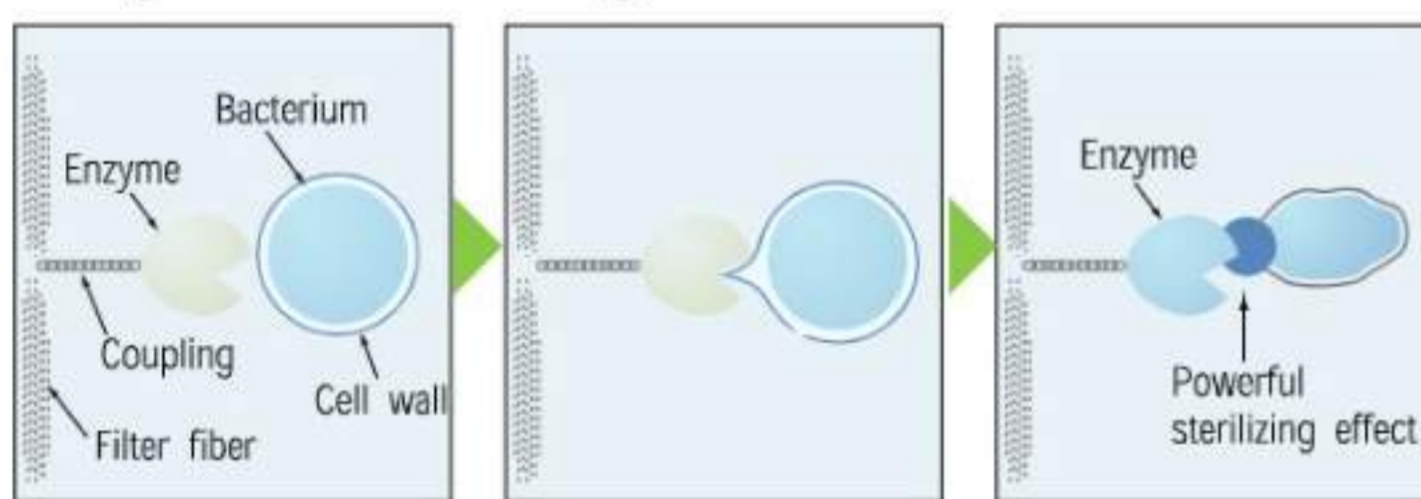

SURE TO DESTROY FUNGI AND BACTERIA, ALSO EFFECTIVE ON VIRUSES AND ALLERGENIC COMPOUNDS (CAT HAIR, DUST MITE, POLLEN ETC.)

Enzymes used in these filters are naturally occurring lytic enzymes. The lytic enzymes attack cell walls of microorganisms trapped on a filter and destroy them and doing so, have a powerful sterilizing which will effectively decrease the number of molds and bacteria. Natural Enzyme Filter will clean and sanitize air passing through it to keep air in the room clean and safe.



DEODORIZING SOLAR FILTER

Natural Solar Filter



The deodorizing ability of this filter can be easily restored simply by cleaning and exposing to the sunlight



It will keep the air fresh by deodorizing the molecules causing odor. Its deodorizing power can be restored by washing with water and drying under the sun, as such it is capable of repeat use.

Feature Guide

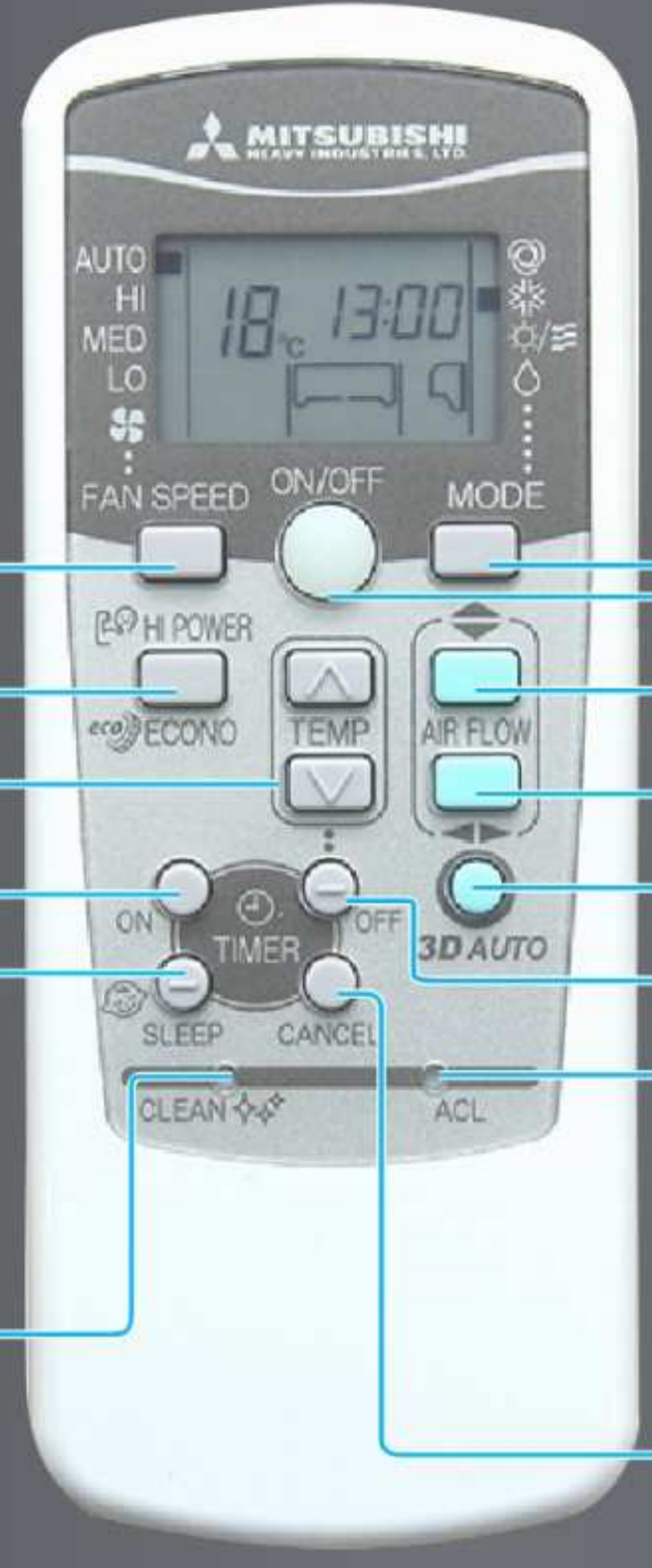

FAN SPEED button
Each time the button is pushed, the indicator is switched over in turn.

HI POWER/ECONO button
This button changes the HIGH POWER/ECONOMY mode.

TEMPERATURE button
This button sets the room temperature. (This button changes the present time and TIMER time.)

ON TIMER button
This button selects ON TIMER operation.

SLEEP button
This button changes to SLEEP operation.

CLEAN switch
This switch changes the CLEAN mode.

OPERATION MODE select button
Each time the button pushed, the indicator is switched over in turn.

ON/OFF (luminous) button
Press for starting operation, press again for stopping.

AIR FLOW (UP/DOWN) button
This button changes the air flow (up/down) mode.

AIR FLOW (LEFT/RIGHT) button
This button changes the air flow (left/right) mode.

3D AUTO button
This button sets 3D AUTO operation.

OFF TIMER button
This button selects OFF TIMER operation.

ACL switch
Switch for resetting microcomputer and setting time.

CANCEL button
This button cancels the ON timer, OFF timer, and SLEEP operation.

• The above illustration shows all controls, but in practice only the relevant parts are shown.



Electricity Saving
Hybrid AC For Electricity Saving Upto 47%*



High Capacity Machines
We have designed the machines using higher capacity compressor + Bigger Condenser Unit for maximum heat rejection for better cooling & higher energy efficiency, thereby we claim for Maximum Cooling Capacities.

INTELLIGENT AIRFLOW CONTROLS



Jet Air Flow
Aircraft technology was used in the design of the air conditioner's airflow system. We used the same aerodynamic analysis technology as used in developing jet engines.



3D Air
3D Auto For Air Distribution in 108 Direction.



Long Reach Air Flow
Jet air flow technology gives long reach airflow upto 15 mtr. for 1.5 times bigger coverage compared to conventional AC.

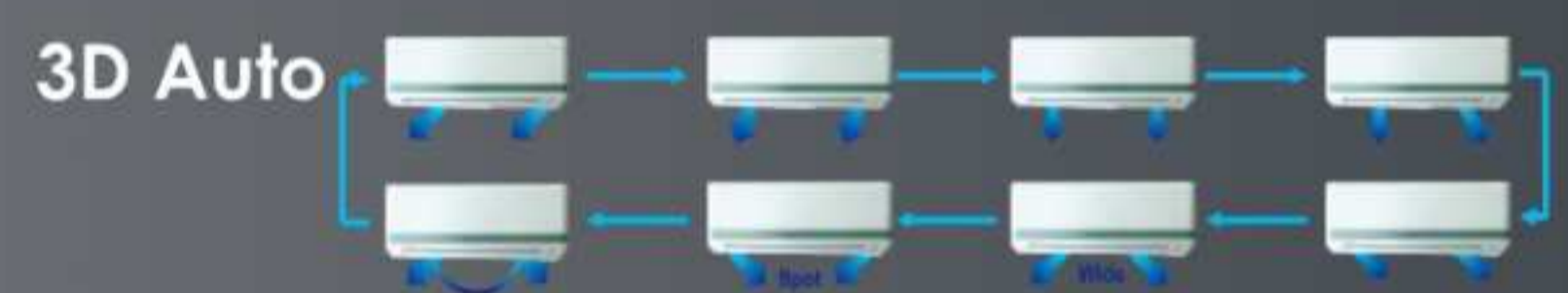

Up/ Down Swing
The UP/DOWN flap can be adjusted to the preferred operations angle, ranging from horizontal to perpendicular.



Position Of Installation
You can set the vertical louver movement at the time of installation to avoid the short cycling of cool air when AC indoor unit is installed in extreme right or left of the area to be air conditioned.



Lateral Swing
It sends a pleasant breeze to a wide range in the room by swinging the louver to right and left automatically. Louver angle can be fixed at any desired position.



New Louver
Due to redesigned size and shape, the new louver has been increased in surface area by 80%. In addition to increase of air flow volume, it has improved controllability of swinging to right and left.

CLEAN AIR



Self Clean Operation
"Self Clean Operation" is initiated after 2 hours of the unit stopping operation. Users can select whether this mode is utilized or not.



Anti Micro Bial Fan
The blower fan has undergone anti- microbial treatment of resist mold and germs, making the system clean and state. Foul odors and molds, etc. Which can occur when an air conditioning system is not in operation are prevented.



Solar Filter
Recyclable filter because of its repeatedly restorable deodorizing power. It can keep air fresh by deodorizing at molecules causing odors plentiful in the room. As its deodorizing power can be restored only by washing with water and dry under the sun, it is an Recyclable deodorizing filter usable repeatedly.



Natural Enzyme Filter
Highest disease disinfection efficiency Natural Enzyme Filter with a working mechanism of MHI Air Conditioner to suck up the disease contained air to pass into the Natural Enzyme Filter. The function of the Natural Enzyme filter will then do its duty to destroy the Cell Walls, and when the Cell Walls have been destroyed, all diseases will then die from the natural mechanism, resulting in sending out the safe and pure air from the MHI Air Conditioner.



24- Hours Ion
The air conditioner main body employs a tourmaline- coated sheet. The sheet generates negative ions around the clock. Even when the air conditioner is not running, it generates as many negative ions (2,500- 3,000/cc) as a forest, stream or fall does, allowing you to experience them without incurring any electricity charges.



Anti Bacterial Filter
Anti Bacterial Filter is a washable nylon wire mesh filter used for filtering the room air, having dust & common bacteria of 40-50 microns. There by making room air clean & free of bacteria.

CONVENIENT & ECONOMY FUNCTION



Auto Restart

Power blackout auto restart function is a function that records the operational status of the air-conditioner immediately prior to it being switched off by a power cut and then automatically resumes operations at that point after the power has been restored.



Economy

The unit realized effective energy saving operation, while still keeping a comfortable cooling and heating.



Dry Operation

The unit dehumidifies the room by intermittent cooling operation.



Mc (Microcomputer- Operated Defrosting)

This mode automatically eliminates frost, and helps minimize excessive operation in other modes.



Backup Switch

On the main unit, there is a backup on/off switch, which is useful when you can't use remote control or batteries are.



Longer Refrigerant Pipe Length

Long Distance piping flexibility allows the outdoor unit to be placed far from the indoor unit. This adds to convenience and facilitates easy installation of the ACs.



Luminous Button

"Luminous button" in remote controls even "glows in the dark". It is possible to operate all desired functions of the unit with the click of a button.



Sleep Mode

The room temperature is automatically controlled during the set sleep mode period, ensuring that room temperature will not get too cold or too hot.

COMFORTABLE FUNCTION :



Automatic

The air conditioner automatically selects from among heating, cooling and dry operations.



Hi Power Cooling

The unit can operate continuously in "HI POWER" mode for 15 minutes. This mode is convenient to reach the desired temperature quickly.



Fuzzy Auto Mode

Automatically, the unit determines its operating mode and temperature setting based on a fuzzy calculation, and adjusts the inverter frequency.



Auto Flap Mode:

Whatever the operating mode is, the unit automatically selects the optimal angle.



Memory Flap:

While the flap is swinging, it can be stopped at any angle desired. The flap returns to the position that it was in when operation last stopped.

MAINTENANCE & PREVENTION :



Self Diagnostic

In the Case, when air conditioner malfunction, an internal Micro-Computer Automatically runs Self Diagnosis function displays the flashing LED on the indoor unit and the User is able to identify the problem by referring the user's manual troubleshooting table and inform the problem.



Detachable

The air inlet panel on the indoor unit opens and closes easily, making filter cleaning simple. The suction panel can also be removed.

TIMER



On Timer

This facility enables the operation to start a little earlier, so that the room approaches optimum temperature at ON time when the operation is started by ON- TIMER. Thus it will try to be of the temperature you want, When you



Off Timer

The unit stops automatically during the set sleep mode period. Ensuring that room temperature will not get too cold or too hot.



100% Copper

All the Models uses 100% copper pipe in Condenser coil and the Evaporator coil for maintenance free durable life and for better heat transfer.



On/Off Timer

By combining a start timer with a stop timer, you can register two of the day repeatedly.



Control

Cordless Remote Control



FROST PREVENTION FOR HEAT EXCHANGER

INDOOR FAN MOTOR PROTECTION

ABNORMALITY OF OUTDOOR UNIT

OVER CURRENT PROTECTION

COMPRESSOR OVERHEAT PROTECTION

SIGNAL TRANSMISSION ERROR PROTECTION



SENSOR DISCONNECTION PROTECTION

ROOM TEMPERATURE SENSOR

INDOOR HEAT EXCHANGER TEMPERATURE SENSOR

OUTDOOR HEAT EXCHANGER TEMPERATURE SENSOR

DISCHARGE PIPE TEMPERATURE SENSOR

OUTDOOR AIR TEMPERATURE SENSOR

HYBRID⁺ AIRCONDITIONER

TURBOJET
ターボジェット



SRK20CSS-S6/A (1.6[#]Ton) / SRK25CSS-S6/A (2.2Ton)



SRK20CX5-W6 (1.6Ton)



SRK15CX5-W6 (1.3Ton)



Features

Comfortable Air Flow Functions



Comfortable Function



Convenient & Economy Functions

Maintenance



Clean Air

Others



SURROUND COOLING



Long Reach Air Flow

SRK25CSS-S6/A (2.2Ton) →

SRK20CSS-S6/A (1.6[#]Ton) →

SRK20CX5-W6 (1.6Ton)

18.2 Meters**

17.0 Meters**

Specifications			HYBRID+ HEAVY DUTY AC (R410A)		HYBRID+ HEAVY DUTY AC (R32)	
MODEL	Unit		SRK20CSS-S6/A	SRK25CSS-S6/A	SRK15CXS-W6	SRK20CXS-W6
	Indoor Unit		SRK20CSS-S6/A	SRK25CSS-S6/A	SRK15CXS-W6	SRK20CXS-W6
	Outdoor Unit		SRC20CSS-S6/A	SRC25CSS-S6/A	SRC15CXS-W6	SRC20CXS-W6
Ton			1.6#	2.2	1.3	1.6
BEE - Star Rating - 2024			3 Star	2 Star	2 Star	3 Star
Refrigerant Control & Expansion			Dual Capillary Expansion			
Fixed Speed Compressor Type			Super Tropical - Return Cooled Rotary			
Power Source			1 Phase, 230 V, 50 Hz			
Maximum Cooling Capacity*			20997	26272	15252	20301
Rated Cooling Capacity at 100% Load	100% Load	BTU/hr	20216	26017	14330	19329
Rated Cooling Capacity at 50% Load	50% Load		Not Applicable for Fixed Speed AC			
Maximum Cooling Capacity*			6154	7700	4470	5950
Rated Cooling Capacity at 100% Load	100% Load	Watts	5925	7625	4200	5665
Rated Cooling Capacity at 50% Load	50% Load		Not Applicable for Fixed Speed AC			
Rated Power Consumption at 100% Load	100% Load	watts	1485	2050	1140	1420
Rated Power Consumption at 50% Load	50% Load		Not Applicable for Fixed Speed AC			
Rated EER / COP at 100% Load	100% Load	W/w	3.99	3.72	3.68	3.99
Rated EER / COP at 50% Load	50% Load		Not Applicable for Fixed Speed AC			
BEE Rated Indian Seasonal Energy Efficiency Ratio	ISEER		3.99	3.72	3.68	3.99
Input Power** (Minimum ~ Maximum)		Watts	1250 ~ 1485	1800 ~ 2050	900 ~ 1140	1200 ~ 1420
Current (minimum ~ maximum) **		A	5.6 ~ 6.6	8.0 ~ 9.2	4.1 ~ 5.1	5.0 ~ 6.1
Dimension (H x W x D)	Indoor Unit	mm	339 x 1197 x 262	339 x 1197 x 262	290 x 870 x 230	339 x 1197 x 262
	Outdoor Unit	mm	640 x 850 (+65) x 290	750 x 880 (+88) x 340	595 X 780 (+62) X 290	595 x 780 (+62) x 290
Net Weight	Indoor Unit	Kgs	16	16	10	16
	Outdoor Unit	Kgs	41	57	32	36
Air Flow (CMH)	Indoor Unit	m3/hr	1350	1450	850	1300
Long Reach AirFlow Upto	Indoor Unit	Meter	17.06	18.28	6.1	17
Sound Level (H/M/L)	Indoor Unit	dB	43 / 40 / 37	46 / 42 / 39	41 / 34 / 27	40 / 37 / 34
Louver Swing	Indoor Unit		3D + 3D AUTO			
Special Filter	Indoor Unit		Enzyme + Photocatalytic Deodorizing Filter + Anti Bacterial			
Blower Fan	Indoor Unit		Anti - Micro Bial			
DC Fan Motor Speed	Indoor Unit		Auto / Powerful / High / Med / Low/ Dry			
Refrigerant Injection in Coil	Indoor Unit		5 Point - Multi Port			
Refrigerant			R410A		R32	
Refrigerant Piping	Liquid Line	mm	6.35 (1/4")		6.35 (1/4")	6.35 (1/4")
	Gas Line	mm	15.88 (5/8")		12.7 (1/2")	15.88 (5/8")
Main Power Supply to	Outdoor Unit		2.5 mm ² x 3 cores (including earthing cable)			
Connecting wiring between	IDU & ODU		2.5 mm ² x 4 cores (including earthing cable)			
Area Coverage ***	Sq. Meter		15.97 ~ 26.01	27.87 ~ 41.80	12.54 ~ 17.18	15.97 ~ 23.23

Refrigerant Pipe Length

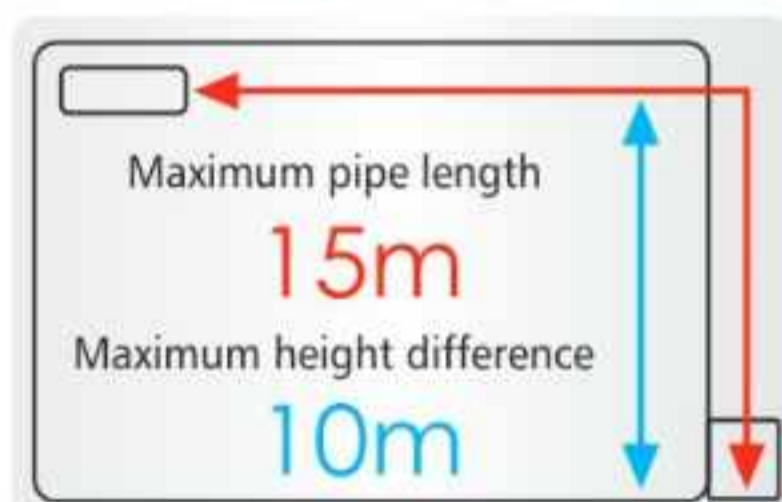

SRK20CSS-S6/A

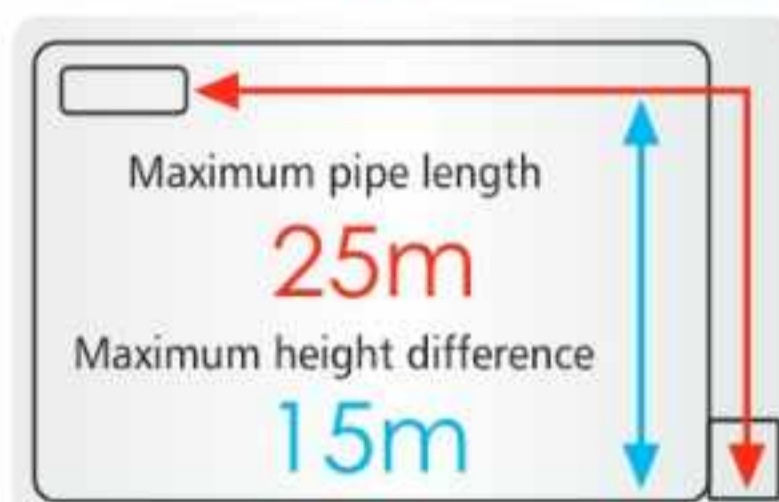

SRK25CSS-S6/A
SRK20CXS-W6

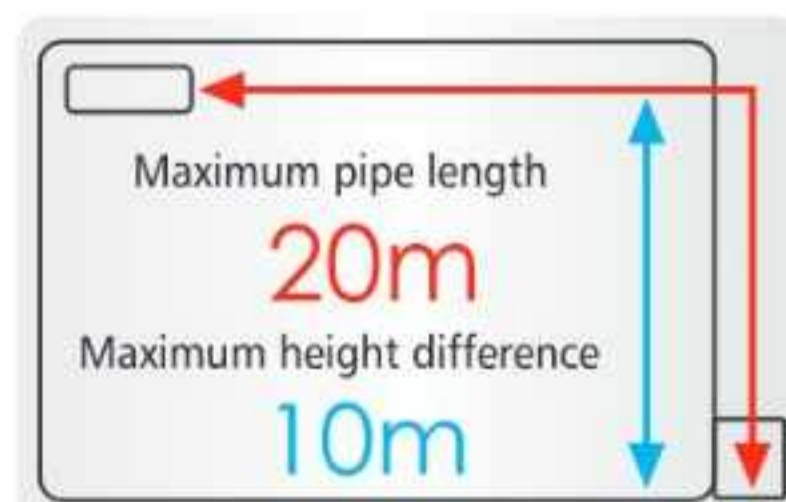

SRK15CXS-W6



SRC20CSS-S6/A



SRC25CSS-S6/A



SRK15CXS-W6, SRK20CXS-W6

* Cooling Capacity is derived Maximum during evening & night when the temperature is less than 31°C

** Under Standard Installation & Lab Test Condition

As per BEE its 1.69 ton

*** Customers need to seek guidance from the Authorized Dealer / Expert for the AC unit capacity selection before ordering any AC unit. Area coverage is subject to checking of the site conditions like - Terrace / Wall / Glass windows exposed to direct sunlight, of the area to be Air- conditioned & room temperature requirement & outdoor temperature conditions. Company will not be responsible if there will be cooling issues due to improper selection of capacity of the AC units.

ISEER = INDIAN SEASONAL ENERGY EFFICIENCY RATIO

HYBRID+ AIRCONDITIONER



SRK13CRS-56 (1.1 Ton)

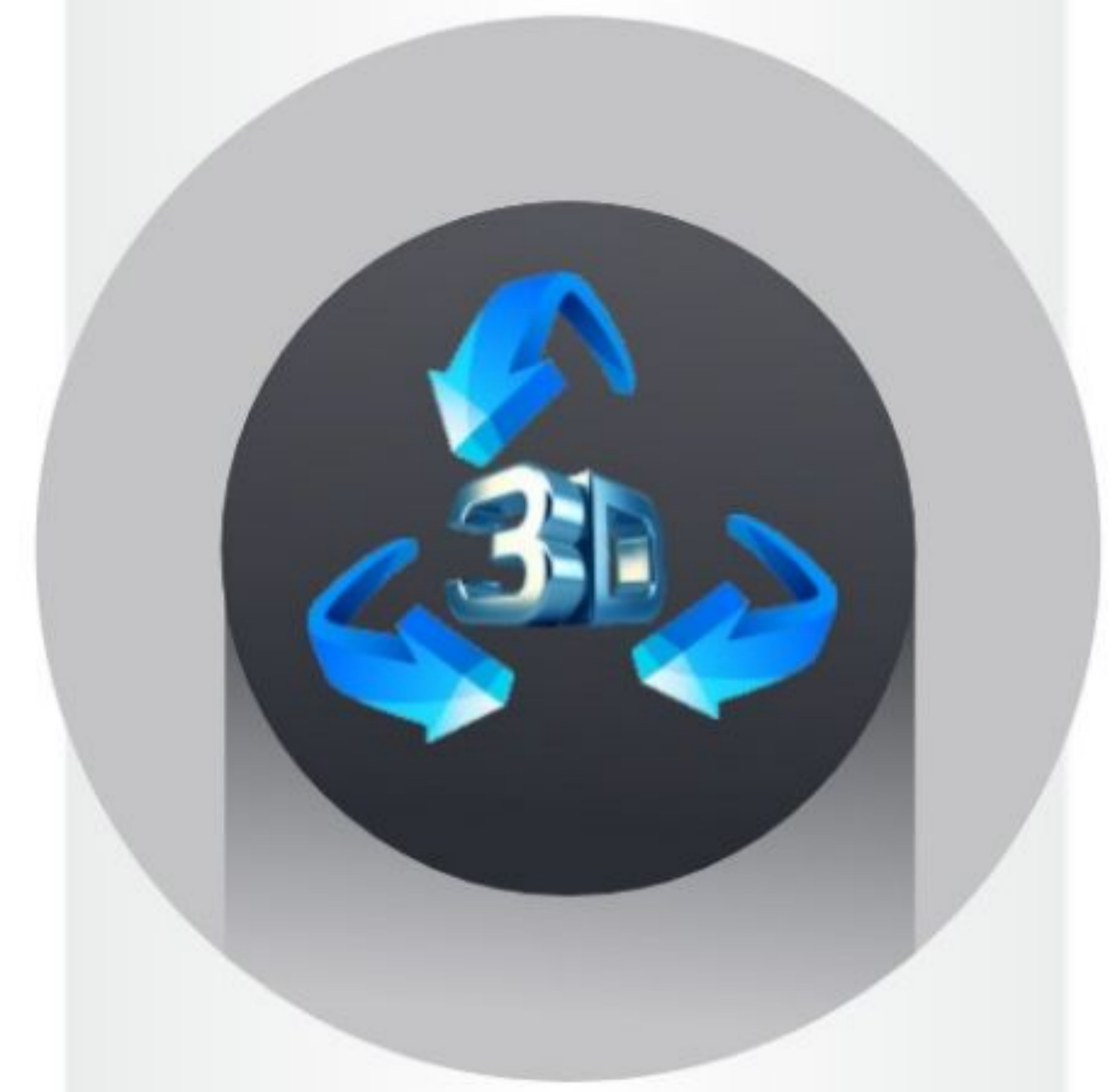

SURROUND COOLING

Features

Comfortable Air Flow Functions



Clean Air



Maintenance



Comfortable Function

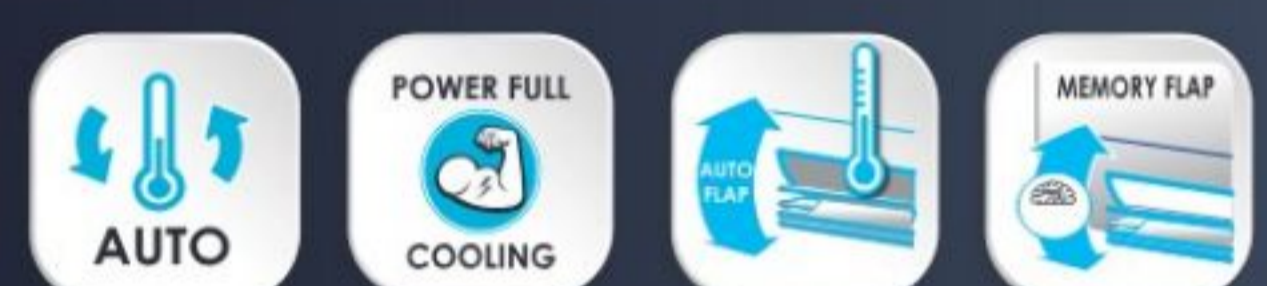

Convenient & Economy Functions



Others



Long Reach Air Flow



SRK13CRS-56 (1.1 Ton) →

6.09 Meters**

Specifications			HYBRID+ HEAVY DUTY AC (R410A)
MODEL	Unit		SRK13CRS-S6
	Indoor Unit		SRK13CRS-S6
	Outdoor Unit		SRC13CRS-S6
Ton			1.1
BEE - Star Rating - 2024			2 Star
Refrigerant Control & Expansion			Dual Capillary Expansion
Fixed Speed Compressor Type			Super Tropical - Return Cooled Rotary
Power Source			1 Phase, 230 V, 50 Hz
Maximum Cooling Capacity*			13501
Rated Cooling Capacity at	100% Load	BTU/hr	12283
Rated Cooling Capacity at	50% Load		Not Applicable for Fixed Speed AC
Maximum Cooling Capacity*			3957
Rated Cooling Capacity at	100% Load	Watts	3600
Rated Cooling Capacity at	50% Load		Not Applicable for Fixed Speed AC
Rated Power Consumption at	100% Load	watts	1000
Rated Power Consumption at	50% Load		Not Applicable for Fixed Speed AC
Rated EER / COP at	100% Load	W/w	3.60
Rated EER / COP at	50% Load		Not Applicable for Fixed Speed AC
BEE Rated Indian Seasonal Energy Efficiency Ratio	ISEER		3.60
Input Power ** (Minimum ~ Maximum)	Watts		700 ~ 1000
Current (minimum ~ maximum) **	A		4.0 ~ 4.7
Dimension (H x W x D)	Indoor Unit	mm	268 x 790 x 213
	Outdoor Unit	mm	595 x 780 x 290
Net Weight	Indoor Unit	Kgs	9.5
	Outdoor Unit	Kgs	32
Air Flow (CMH)	Indoor Unit	m3/hr	750
Long Reach AirFlow Upto	Indoor Unit	Meter	6.09
Sound Level (H/M/L)	Indoor Unit	dB	38 / 34 / 31
Louver Swing	Indoor Unit		3D + 3D AUTO
Special Filter	Indoor Unit		Enzyme + Solar + Anti - Bacterial Filter
Blower Fan	Indoor Unit		Anti - Micro Bial
DC Fan Motor Speed	Indoor Unit		Auto / Powerful / High / Med / Low / Dry
Refrigerant Injection in Coil	Indoor Unit		4 Point - Multi Port
Refrigerant Piping	Liquid Line	mm	6.35 (1/4")
	Gas Line	mm	12.7 (1/2")
Main Power Supply to	Indoor Unit		2.5 mm ² x 3 cores (earthing cable)
Connecting wiring between	B/w IDU &		2.5 mm ² x 4 cores (earthing cable)
Area Coverage ***	Sq. Meter		11.98 ~ 15.97

Refrigerant Pipe Length

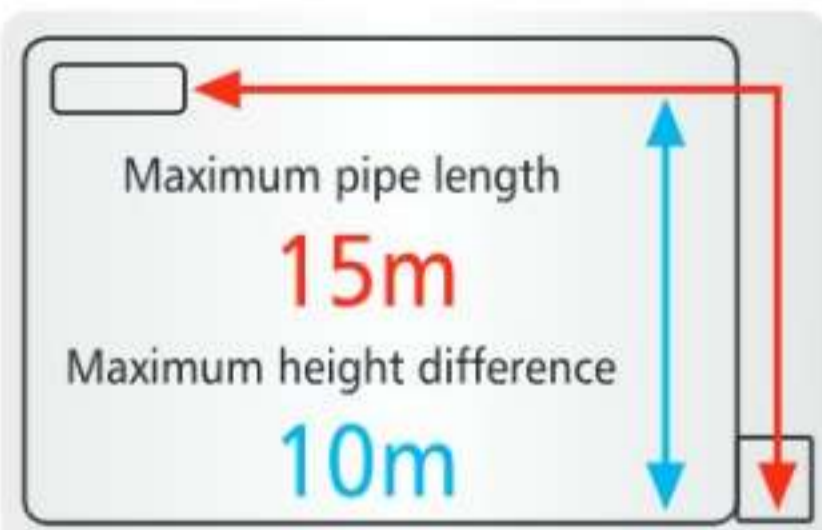

SRK13CRS-S6



SRC13CRS-S6

* Cooling Capacity is derived Maximum during evening & night when the temperature is less than 31°C

** Under Standard Installation & Lab Test Condition

*** Customers need to seek guidance from the Authorized Dealer / Expert for the AC unit capacity selection before ordering any AC unit. Area coverage is subject to checking of the site conditions like - Terrace / Wall / Glass windows exposed to direct sunlight, of the area to be Air- conditioned & room temperature requirement & outdoor temperature conditions. Company will not be responsible if there will be cooling issues due to improper selection of capacity of the AC units.

ISEER = INDIAN SEASONAL ENERGY EFFICIENCY RATIO

HYBRID⁺ AIRCONDITIONER

TURBOJET
ターボジェット

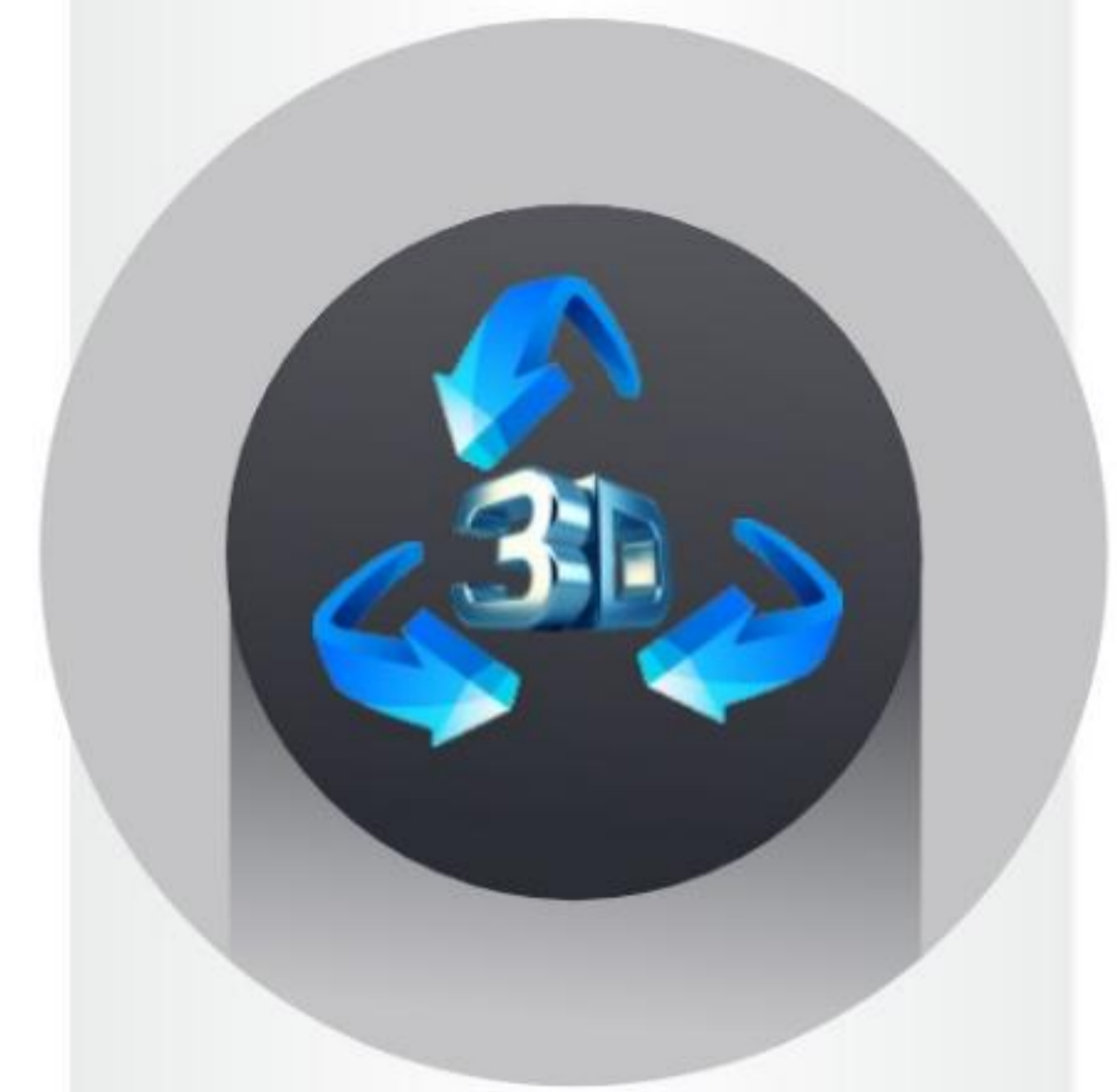

SURROUND COOLING



1.19 mtr



SRK 24CW-56 (1.95 Ton)
SRK 25CW-X-56 (1.95 Ton)

Features

Comfortable Air Flow Functions



Comfortable Function



Convenient & Economy Functions



Maintenance



Clean Air



Others



Protection



Model SRK24CW-S6 with 2D Air flow only



Long Reach Air Flow

SRK25CW-X-56 (1.95 Ton) →

18.2 Meters**

SRK24CW-56 (1.95 Ton) →

17.0 Meters**

Specifications			HYBRID+ HEAVY DUTY AC (R410A)	
MODEL	Unit		SRK24CW-S6	SRK25CWX-S6
	Indoor Unit		SRK24CW-S6	SRK25CWX-S6
	Outdoor Unit		SRC24CW-S6	SRC25CWX-S6
Ton			1.95	1.95
BEE - Star Rating - 2024			2 Star	3 Star
Refrigerant Control & Expansion			Dual Capillary Expansion	
Fixed Speed Compressor Type			Super Tropical - Return Cooled Rotary	
Power Source			1 Phase, 230 V, 50 Hz	
Rated Cooling Capacity at 100% Load		BTU/hr	23406	23458
Rated Cooling Capacity at 50% Load			Not Applicable for Fixed Speed AC	
Rated Cooling Capacity at 100% Load		Watts	6860	6875
Rated Cooling Capacity at 50% Load			Not Applicable for Fixed Speed AC	
Rated Power Consumption at 100% Load		watts	1820	1635
Rated Power Consumption at 50% Load			Not Applicable for Fixed Speed AC	
Rated EER / COP at 100% Load		W/w	3.77	4.20
Rated EER / COP at 50% Load			Not Applicable for Fixed Speed AC	
BEE Rated Indian Seasonal Energy Efficiency Ratio	ISEER		3.77	4.20
Input Power ** (Minimum ~ Maximum)		Watts	1570 ~ 1820	1385 ~ 1635
Current (minimum ~ maximum) **		A	7.0 ~ 8.1	6.2 ~ 7.3
Dimension (H x W x D)	Indoor Unit	mm	339 x 1197 x 262	339 x 1197 x 262
	Outdoor Unit	mm	640 x 800 (+71) x 290	750 x 880 (+88) x 340
Net Weight	Indoor Unit	Kgs	16	16
	Outdoor Unit	Kgs	44	52.5
Air Flow (CMH)	Indoor Unit	m3/hr	1300	1400
Long Reach AirFlow Upto	Indoor Unit	Meter	17.06	18.29
Sound Level (H/M/L)	Indoor Unit	dB	46 / 42 / 39	47 / 43 / 40
Louver Swing	Indoor Unit		2D	3D + 3D AUTO
Special Filter	Indoor Unit		Natural Enzyme + Photocatalytic Deodorizing Filter + Anti Bacterial	
Blower Fan	Indoor Unit		Anti - Micro Bial	
DC Fan Motor Speed	Indoor Unit		Auto / Powerful / High / Med / Low / Dry	
Refrigerant			R410A	
Refrigerant Piping	Liquid Line	mm	6.35 (1/4")	6.35 (1/4")
	Gas Line	mm	15.88 (5/8")	15.88 (5/8")
Main Power Supply to	Outdoor Unit		2.5 mm ² x 3 cores (earthing cable)	
Connecting wiring between	IDU & ODU		2.5 mm ² x 4 cores (earthing cable)	
Area Coverage ***	Sq. Meter		23.22 ~ 32.5	27.88 ~ 37.17

Refrigerant Pipe Length

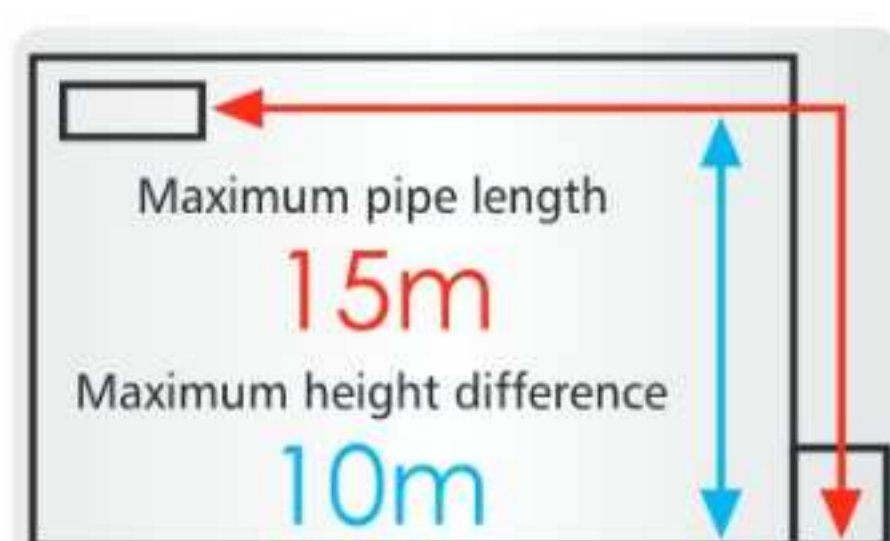

SRK24CW-S6

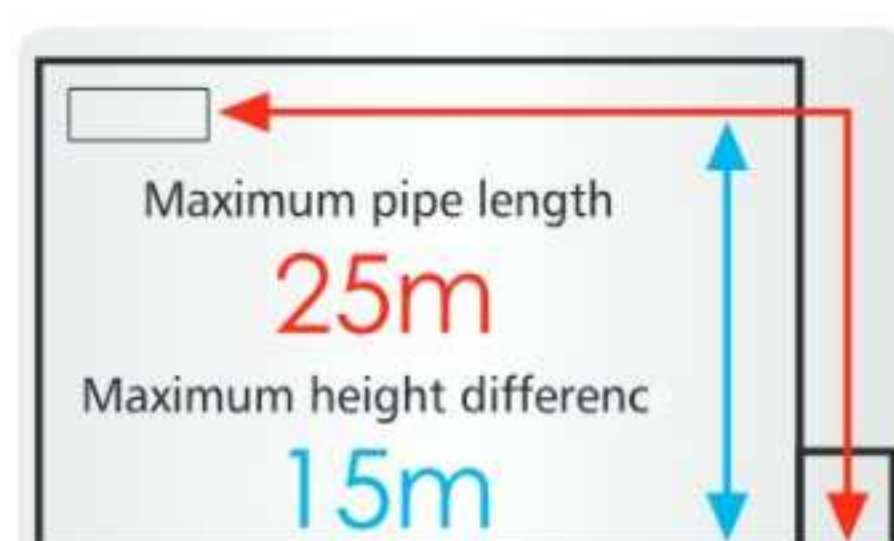

SRK25CWX-S6



SRC24CW-S6



SRC25CWX-S6

* Cooling Capacity is derived Maximum during evening & night when the temperature is less than 31°C

** Under Standard Installation & Lab Test Condition

Model SRK24CW-S6 with 2D Air flow only

*** Customers need to seek guidance from the Authorized Dealer / Expert for the AC unit capacity selection before ordering any AC unit. Area coverage is subject to checking of the site conditions like - Terrace / Wall / Glass windows exposed to direct sunlight, of the area to be Air- conditioned & room temperature requirement & outdoor temperature conditions. Company will not be responsible if there will be cooling issues due to improper selection of capacity of the AC units.

ISEER = INDIAN SEASONAL ENERGY EFFICIENCY RATIO

HYPER INVERTER

ARTIFICIAL INTELLIGENCE



AREA COVERAGE TABLE - HYPER INVERTER

MODEL	CAPACITY (Ton)	AREA COVERAGE
SRK13YYM-W6	1.0 (0.25 Ton ~ 1.1 Ton)	Upto 13.0 sq.mtr.***
SRK13YXP	1.0 (0.23 Ton ~ 1.05 Ton)	Upto 13.0 sq.mtr.***
SRK13YXS	1.1 (0.25 Ton ~ 1.25 Ton)	Upto 15.79 sq.mtr.***
SRK18YXP	1.5 (0.37 Ton ~ 1.5 Ton)	Upto 17.2 sq.mtr.***
SRK18YYM-W6	1.6 (0.37 Ton ~ 1.68 Ton)	Upto 22.3 sq.mtr.***
SRK50ZS-S6	1.50 (0.48 Ton ~ 1.60 Ton)	Upto 18.58 sq.mtr.***
SRK18YXS2	1.65 (0.48 Ton ~ 1.96 Ton)	Upto 26.0 sq.mtr.***
SRK24YYM-W6	2.1 (0.37 Ton ~ 2.2 Ton)	Upto 30.20 sq.mtr.***
SRK24YVS	2.2 (0.65 Ton ~ 2.36 Ton)	Upto 41.8 sq.mtr.***

* Check for design condition and corresponding parameters like roof / window exposed to direction sunlight, of the area to be Air- conditioned.

DC PAM Inverter Twin Rotary Compressor

Mitsubishi Heavy Duty AC of 2.0 ton & above capacity units uses DC PAM Inverter Twin Rotary Compressor which performs high efficiency operation under the wide range capacity variance from low 10% to high 120% of its nominal capacities using DC PAM Technology . Besides low vibration & low sound level, high efficiency is achieved by the optimization of mechanical parts dimension and by the application of high power Neodymium motor.



Advantages :

- Neodymium motor
- 1.5 times Higher compression ratio
- Wider range of operation
- Lower vibration & noise
- Zero Starting currents
- Improved efficiency with 0.1Hz step up
- Higher efficiency

Fuzzy Auto Mode

The temperature and humidity sensors check room conditions. The unit automatically controls the operation mode and the setting temperature to operate efficiently. Operation mode and cooling/heating capacity is controlled automatically according to one setting temperature. Fuzzy auto mode offers automatic comfort temperature control even if weather condition changes quickly.

New Inverter Vector Control

New Inverter Control has applied new advanced technology of Vector control and has realized high efficiency.

- Smooth operation from low speed to high speed
- Energy efficiency is further improved in low speed range.
- Smooth Sine Voltage Wave form are attained



EEV = Electronic Expansion Valve Compressor Protection With AI

*** Customers need to seek guidance from the Authorized Dealer / Expert for the AC unit capacity selection before ordering any AC unit. Area coverage is subject to checking of the site conditions like - Terrace / Wall / Glass windows exposed to direct sunlight, of the area to be Air- conditioned & room temperature requirement & outdoor temperature conditions. Company will not be responsible if there will be cooling issues due to improper selection of capacity of the AC units.

Feature Guide

Comfortable Air Flow Functions



Clean Air



Maintenance



Comfortable Functions



Convenient & Economy Functions



Others



Easy Control

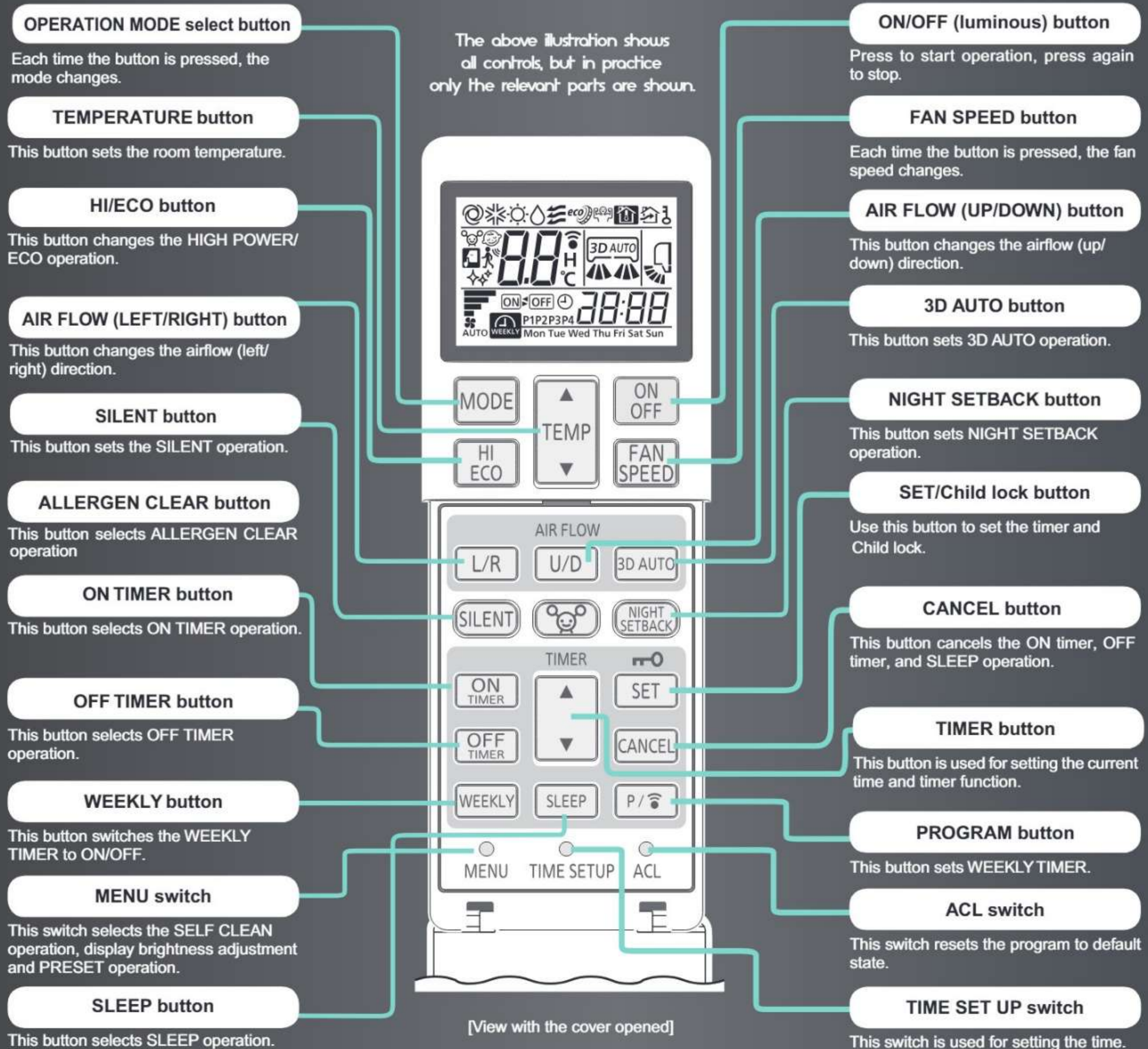

Features Comparison

SL NO.	Features	SRK24YVS-W6	SRK13YXS-W6 SRK18YXS2-W6	SRK50ZS-S6	SRK13YXP-W6 SRK18YXP-W6	SRK13YYM-W6 SRK18YYM-W6 SRK24YYM-W6
1	DC PAM Inverter	✓	✓	✓	✓	✓
2	High Power Cooling	✓	✓	✓	✓	✓
3	Jet Air Flow	✓	✓	✓	✓	✓
4	3D Air	✓	✓	✓		✓
5	3D Auto	✓	✓	✓		✓
6	Auto Flap	✓	✓	✓	✓	✓
7	Memory	✓	✓	✓	✓	✓
8	Up/Down (Horizontal Louver)	✓	✓	✓	✓	✓
9	Lateral Swing (Vertical Louver)	✓	✓	✓		✓
10	Position of Installation	✓	✓	✓		✓
11	Economy Cooling	✓	✓	✓	✓	✓
12	Front Panel Detachable	✓	✓	✓	✓	✓
13	Enzyme Filter	✓	✓	✓		✓
14	Solar Filter (Deodorizing)	✓	✓	✓		✓
15	Anti Micro Bial Fan	✓	✓	✓	✓	✓
16	Self Clean Operation		✓	✓	✓	✓
17	Allergen Filter + Activated Carbon	✓	✓	✓		✓
18	Nano Air Filtration (PM 2.5)					✓
19	Auto Mode	✓	✓	✓	✓	✓
20	Fuzzy Logic	✓	✓	✓	✓	
21	Night Setback			✓		✓
22	Child lock		✓	✓		✓
23	Back-Up Switch	✓	✓	✓	✓	✓
24	Auto Restart	✓	✓	✓	✓	✓
25	Luminous Button	✓	✓	✓	✓	✓
26	100% Copper	✓	✓	✓	✓	✓
27	EEV	✓	✓	✓	✓	✓
28	Self Diagnostic	✓	✓	✓	✓	✓
29	Dry Mode	✓	✓	✓	✓	✓
30	Off timer	✓	✓	✓	✓	✓
31	Sleep Mode	✓	✓	✓	✓	✓
32	MC (Micro Computer)	✓	✓	✓	✓	✓
33	Silent Mode (Ulo Fan Speed)	✓	✓	✓		✓
34	Super Silent in Low Fan	✓	✓	✓	✓	
35	R410A	✓		✓		
36	R32		✓		✓	✓
37	Weekly Timer		✓	✓		✓
38	WiFi - Control Function (Interface Kit)					(Optional)

FROST PREVENTION FOR HEAT EXCHANGER

INDOOR FAN MOTOR PROTECTION

ABNORMALITY OF OUTDOOR UNIT

OVER CURRENT PROTECTION

COMPRESSOR OVERHEAT PROTECTION

SIGNAL TRANSMISSION ERROR PROTECTION



SENSOR DISCONNECTION PROTECTION

ROOM TEMPERATURE SENSOR

INDOOR HEAT EXCHANGER TEMPERATURE SENSOR

OUTDOOR HEAT EXCHANGER TEMPERATURE SENSOR

DISCHARGE PIPE TEMPERATURE SENSOR

OUTDOOR AIR TEMPERATURE SENSOR

EXTENDED WARRANTY

ON HYPER INVERTER HI-WALL AC^S UPTO 2.2 TON

[Subject to warranty termes mentioned in our website]



Genuine Spares & Service Center

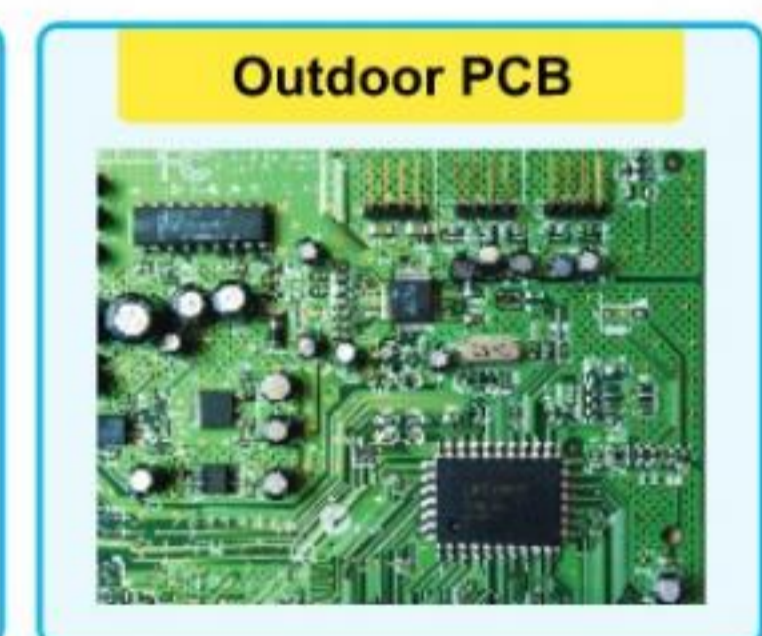

Our Latest Technologies

[Outdoor unit]

Propeller fan

Optimised matching of the propeller fan and the fan motor in order to keep the same capacity as that of previous models with less electrical consumption. Synergy effect with leaf grill has increased efficiency by 5% and quietened the sound.

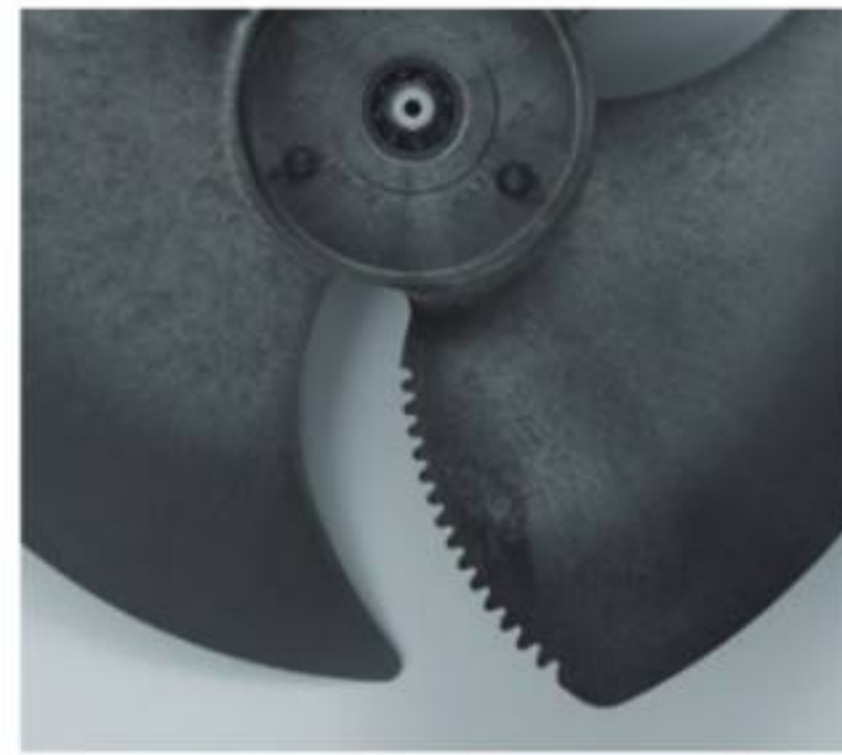

Serration fan

Coated PCB

The printed wiring board of the outdoor unit is coated. It lasts longer due to improved tolerance to humidity.



Heat exchanger

By changing fin configuration from flat sheet to M shape fin, efficiency has increased by 10%. This high dimensional structure provides optimum balance of heat transfer and airflow.

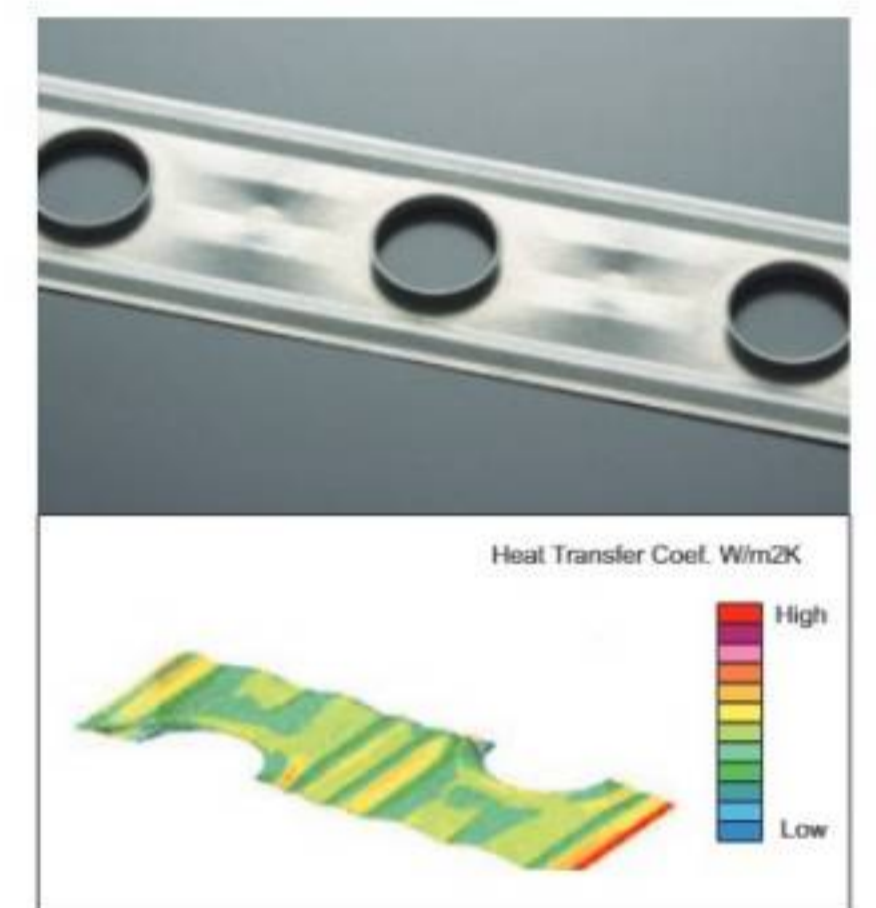

DC Motor

DC fan motor produces high efficiency & high power

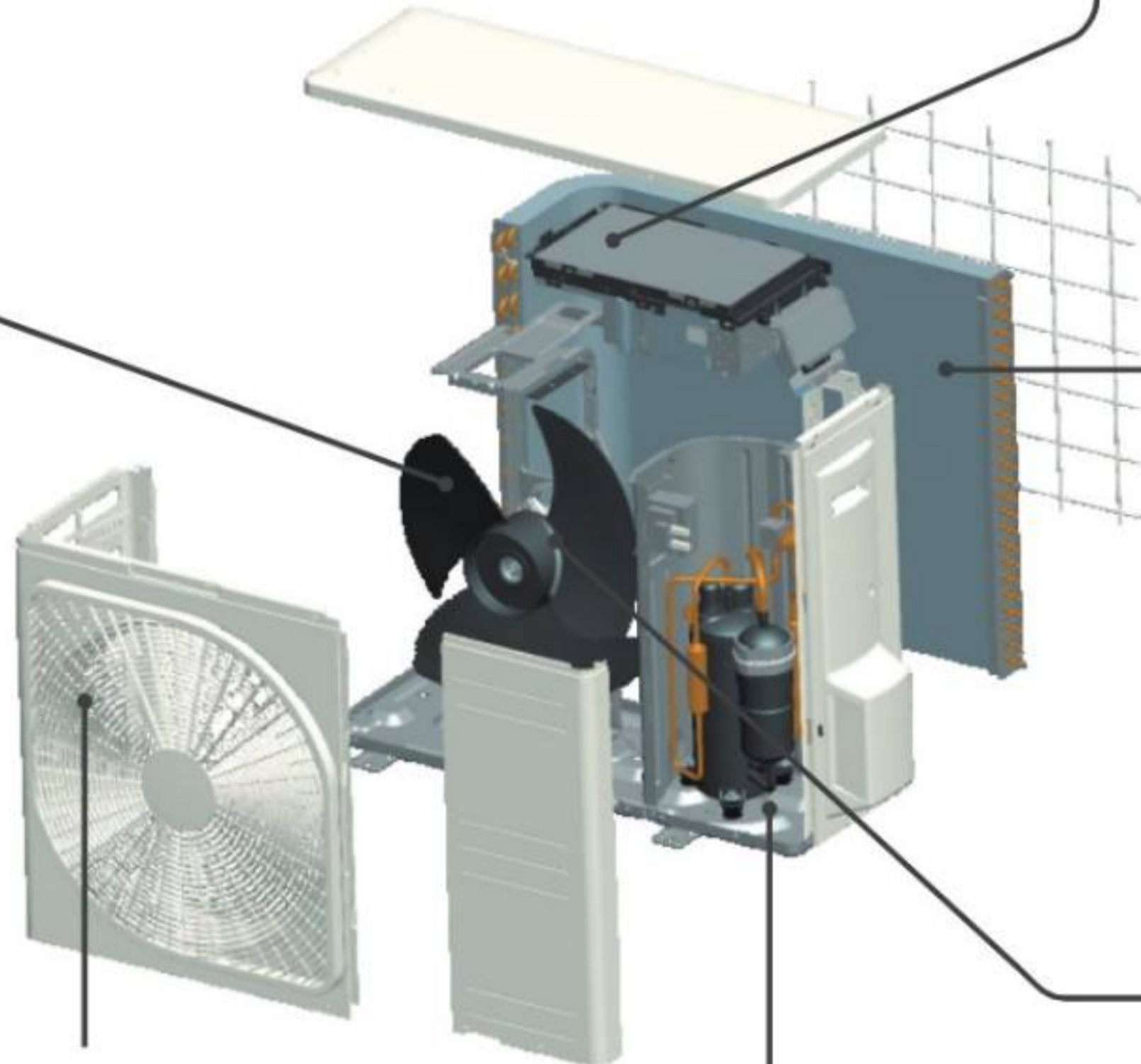

Leaf shape grill

The radial shape grill has been developed in order to send airflow efficiently outside the unit along the grill. Decreasing the load for motor and propeller fan leads to greater energy efficiency and contributes to quieter sound.

Superior corrosion resistance hot dipping steel sheet

Superior corrosion resistance hot dipping steel sheet is applied at the base of outdoor units. It has superior corrosion resistance and scratch resistance properties compared to conventional materials.



[Indoor unit] Heat exchanger

Our optimal combination of fin configuration and copper tube has maximised airflow volume without expanding indoor unit's size in width. Compared with previous models, the heat exchanger efficiency rate has drastically improved by 33%. The fin can maximise airflow volume and save energy simultaneously.

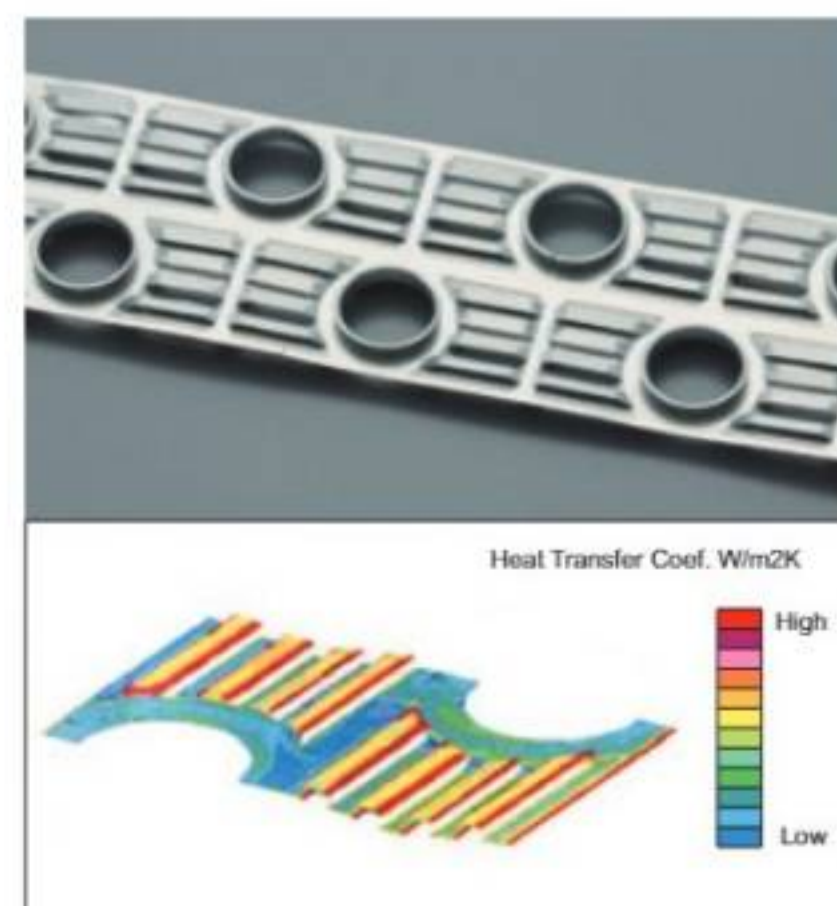

Three Sensors

Control of room temperature and humidity is very important for people to live a comfortable life.

Use of three sensors to control indoor temperature, indoor humidity and outdoor temperature enable unit to obtain optimum air-conditioning.



Sensor for indoor temperature and humidity



Sensor for outdoor temperature

Comfort & Convenience

WEEKLY TIMER OPERATION

Up to 4 programs with timer operation (ON-TIMER / OFF-TIMER) are available for each day of the week. Maximum 28 programs per week can be set. Once set, the timer operation will repeat the same program every week unless otherwise canceled.

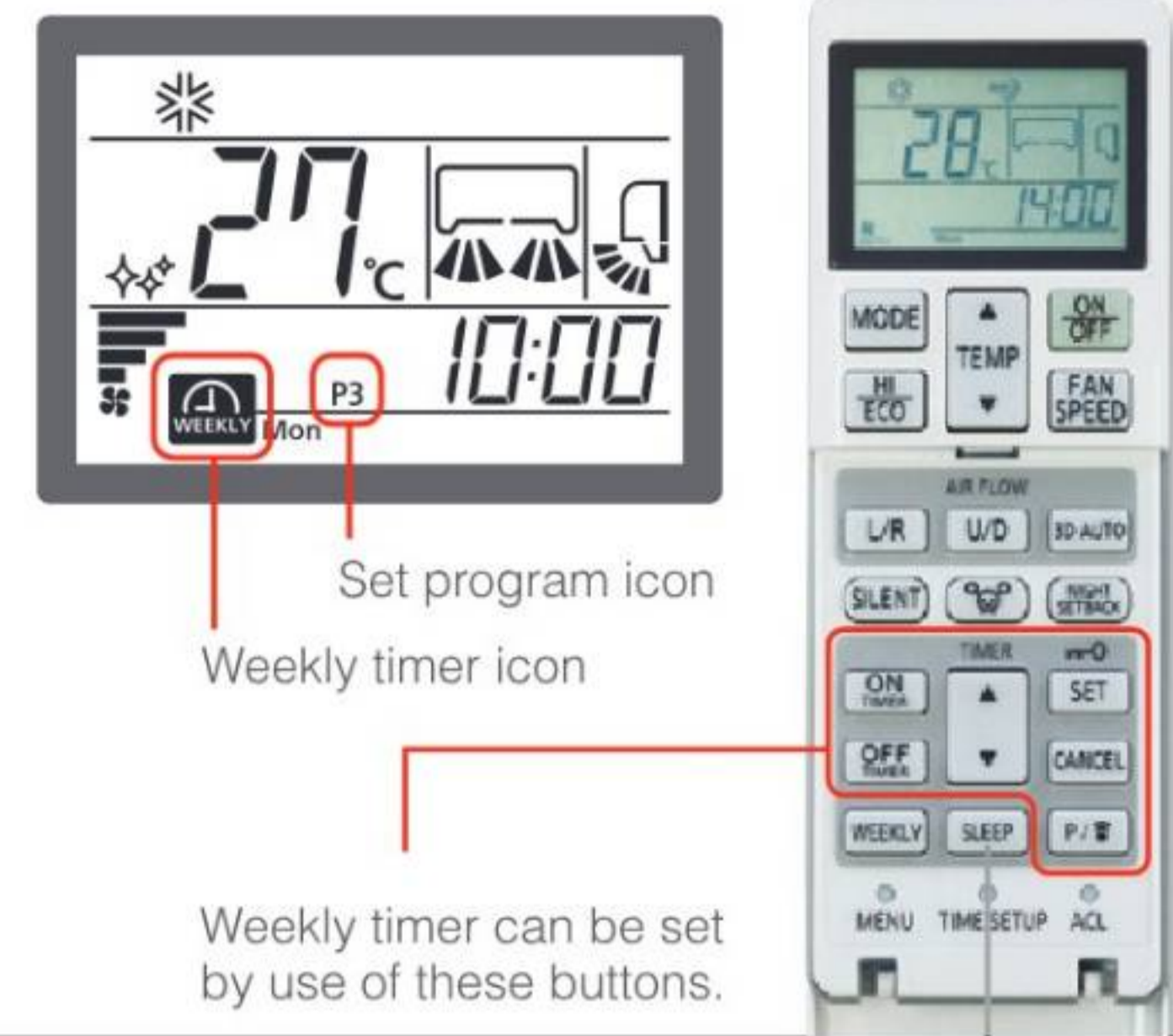

SLEEP TIMER

Too much cooling/heating is not necessary when people go to sleep. This function achieves moderate cooling/heating by adjusting its capacity and more energy saving as well.

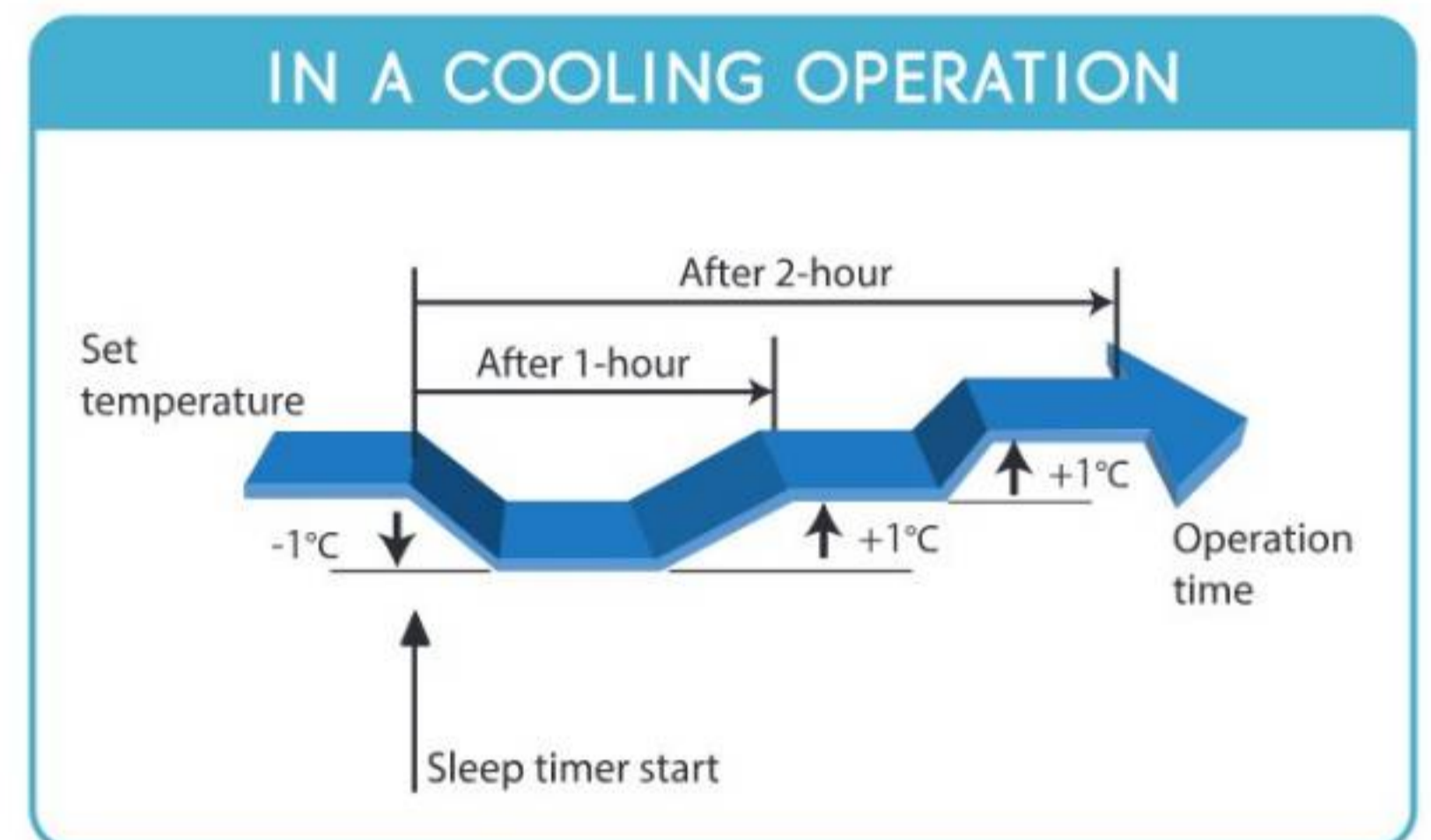
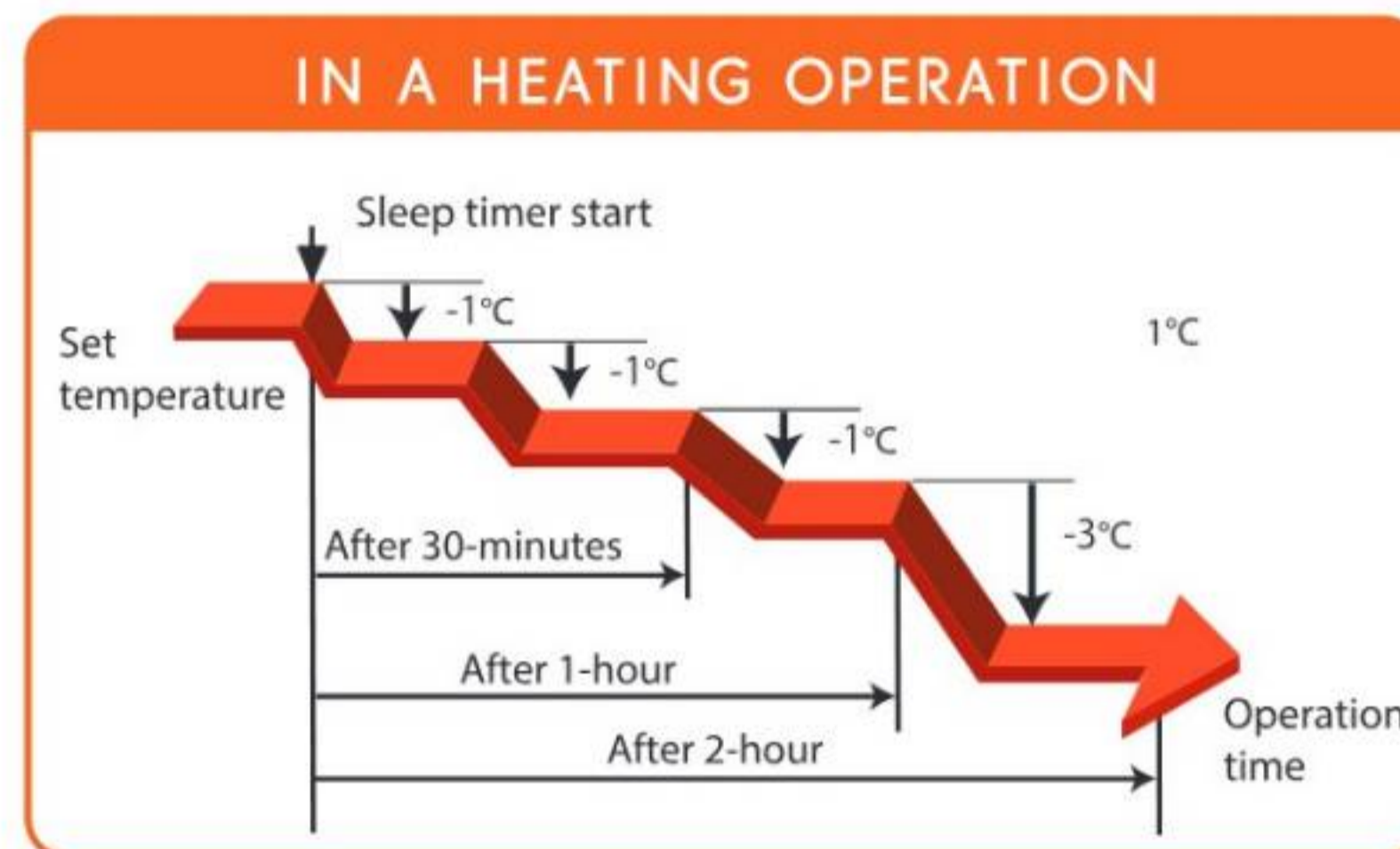

PRE-OPERATION TO COMFORT START-UP

Air conditioner controls room temperature to achieve comfort at the "set time" by 60minutes pre-operation. This is convenient when you wake up and return home at a predetermined time. In ON-TIMER operation, the unit starts the operation a little earlier, so that the room can approach optimum temperature at ON time.

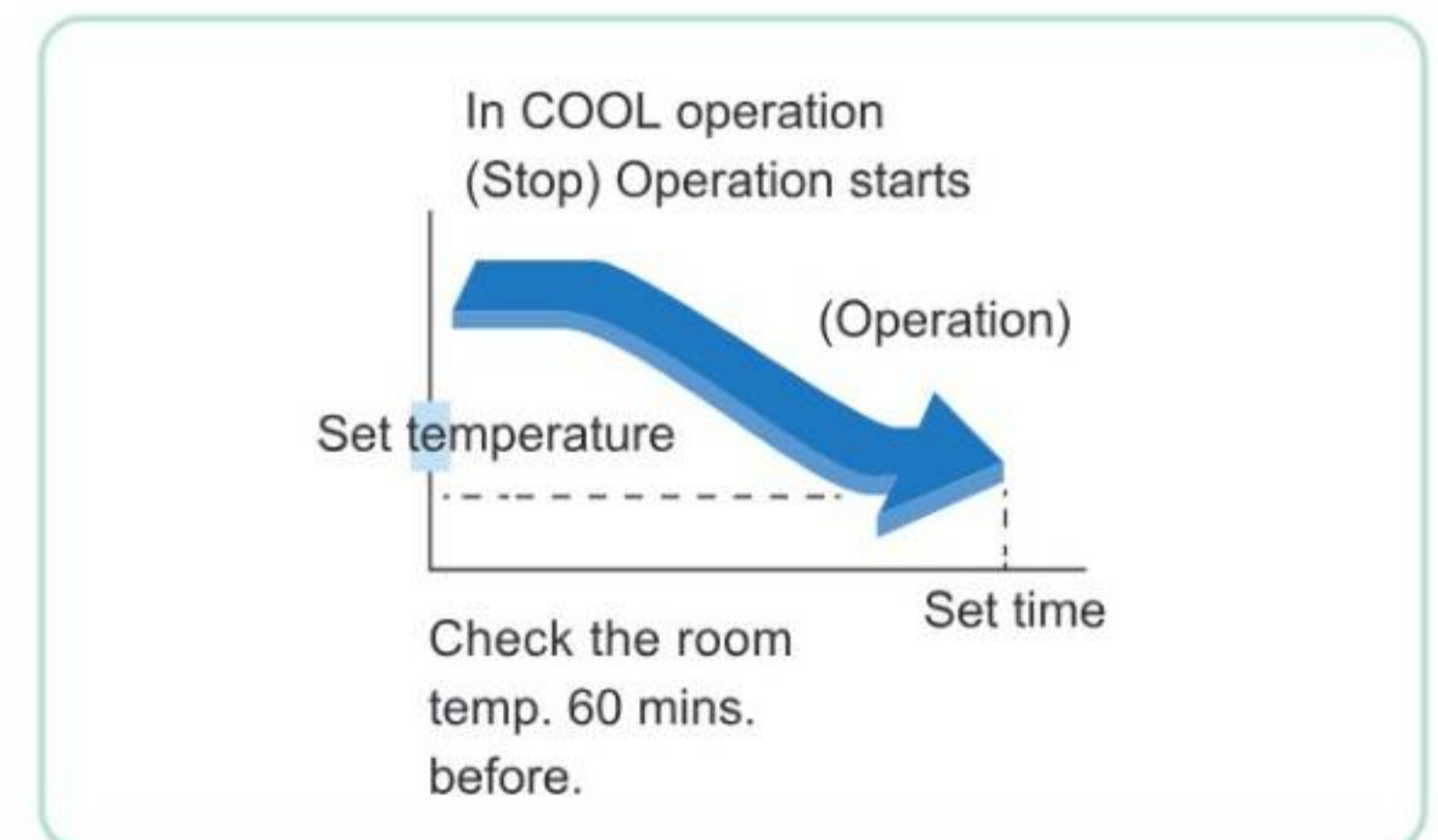

PRESET OPERATION

The Preset Operation features allows customised temperature and airflow settings, which will deliver ultimate comfort with one simple touch of the button.

CHILD LOCK

Blocks the unit preventing tampering and inadvertent operations. This function is useful for families with young children.



Cooling Only

Hyper Inverter ECO SMART

TURBOJET
ターボジェット
Series



SRK13YXP-W6 1.0 Ton (0.23 Ton ~ 1.05 Ton)



SRK18YXP-W6 1.5 Ton (0.37 Ton ~ 1.51 Ton)



LONG REACH AIR FLOW

Powerful air flow is realized by Jet technology. Good for large living rooms and shops. Increase your comfort.

SRK24YVS-W6 (2.2 Ton)

18.28 METERS**



Specifications



				ECO SMART - HYPER INVERTER (R32) - COOLING ONLY	
MODEL	Unit		SRK13YXP-W6		SRK18YXP-W6
	Indoor Unit		SRK13YXP-W6		SRK18YXP-W6
	Outdoor Unit		SRC13YXP-W6		SRC18YXP-W6
Ton - Cooling Only	(minimum ~maximum)		1.0 (0.23 Ton ~ 1.05 Ton)		1.5 (0.37 Ton ~ 1.51 Ton)
BEE Star Rating - 2024			3 Star		3 Star
Compressor Type			Rotary		Rotary
VFD - Variable Frequency Drive			Inverter Vector Control Technology for Higher Effici		
Minimum Compressor RPM			7 ~ 15 RPM - Using Vector Control Technology		
Refrigerant Volume Control Using			Motorized Electronic Expansion Valve for Variable Re		
LCD Remote Control (iPM Controller)			iPM (Intelligent Power Module)		
Power Source			1 Phase, 220 / 230 V , 50 Hz		
Maximum Cooling Capacity at**			12624		19107
Rated Cooling Capacity at	100% Load	BTU/hr	12420		17401
Rated Cooling Capacity at	50% Load		5971		8755
Maximum Cooling Capacity at**	120% Load		3700		5600
Rated Cooling Capacity at	100% Load	Watts	3640		5100
Rated Cooling Capacity at	50% Load		1750		2566
Rated Power Consumption at	100% Load	watts	1070		1730
Rated Power Consumption at	50% Load		397		565
Rated EER / COP at	100% Load	W/w	3.4		2.9
Rated EER / COP at	50% Load		4.4		4.5
Rated Indian Seasonal Energy Efficiency		ISEER	4.2		3.99
Current (Minimum ~ Maximum)**		A	0.70 ~ 5.0		1.1 ~ 7.6
Dimension (H x W x D)	Indoor Unit	mm	262 x 769 x 230		262 x 769 x 230
	Outdoor Unit	mm	540 x 645(+57) x 275		540 x 780(+62) x 290
Net Weight	Indoor Unit	Kgs	7.5		8.5
	Outdoor Unit	Kgs	26.5		30.5
Cooling Coil Row	Indoor Unit	No.s	2		2
Air Flow (CMH)	Indoor Unit	m3/hr	700		850
Long Reach Air Flow Upto	Indoor Unit	Meters	5		5
Self Diagnosis Function	Indoor Unit		Yes		Yes
Sound Level (H/M/L)	Indoor Unit	dB	42 / 32 / 22		43 / 34 / 24
Louver Swing	Indoor Unit		2D (UP & DOWN)		2D (UP & DOWN)
Special Filter	Indoor Unit		Anti Bacterial - Filter		Anti Bacterial - Filter
Fan	Indoor Unit		Anti - Micro Bial Fan		
DC Fan Motor Speed	Indoor Unit		Auto / Powerful / High / Medium / Low (Ultra Low-in-silent mode in SRK24YVS)		
Refrigerant			R32		
Refrigerant Injection in Coil			3 Point - Multi Port		
Refrigerant Piping Thickness:18Gauge(1mm)	Liquid Line	mm	6.35 (1/4")		6.35 (1/4")
	Gas Line	mm	9.52 (3/8")		12.7 (1/2")
Main Power Supply to	Outdoor Unit		2.5 mm ² x 3 cores (including Earthing)		
Connecting wiring	B/w IDU & ODU		2.5 mm ² x 4 cores (including Earthing)		
Area Coverage ***		Sq.Meters	10 ~ 13		13 ~ 17.2

Refrigerant Pipe Length

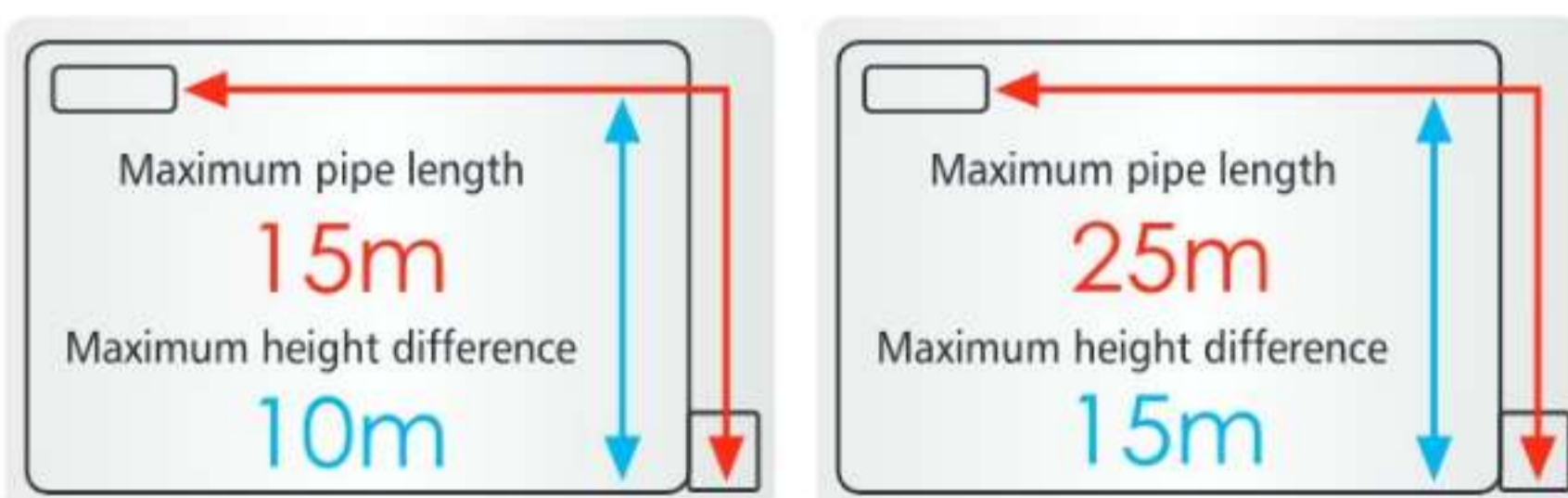

SRK13YXP-W6

SRK18YXP-W6

Remote Control



SRK13YXP-W6
SRK18YXP-W6

** Under Standard Installation & Lab Test Condition

*** Customers need to seek guidance from the Authorized Dealer / Expert for the AC unit capacity selection before ordering any AC unit. Area coverage is subject to checking of the site conditions like - Terrace / Wall / Glass windows exposed to direct sunlight, of the area to be Air- conditioned & room temperature requirement & outdoor temperature conditions. Company will not be responsible if there will be cooling issues due to improper selection of capacity of the AC units.

ISEER = INDIAN SEASONAL ENERGY EFFICIENCY RATIO

Hyper Inverter ECO SMART



Series
1.65 Ton

INDIA'S HIGHEST ISEER HYPER INVERTER

SRK18YXS2-W6 1.65 Ton (0.48 Ton ~ 1.96 Ton)

WITH HIGHEST AIR FLOW 1434 CMH

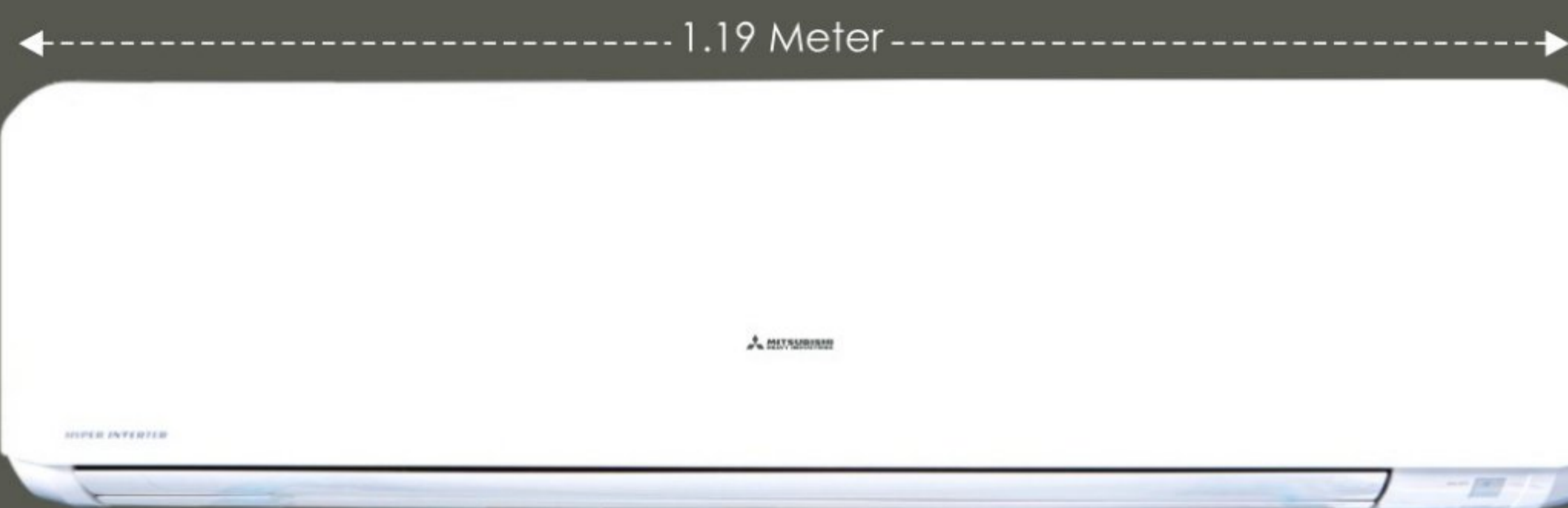

SRK18YXS2-W6 1.65 Ton (0.48 Ton ~ 1.96 Ton)
SRK24YVS-W6 2.2 Ton (0.65 Ton ~ 2.36 Ton)



SRK13YXS-W6 1.1 Ton (0.25 Ton ~ 1.25 Ton)



SURROUND COOLING



LONG REACH AIR FLOW

Powerful air flow is realized by Jet technology. Good for large living rooms and shops. Increase your comfort.

SRK18YXS2-W6 (1.65 Ton) 17.0 METERS**
SRK24YVS-W6 (2.2 Ton) 18.2 METERS**



Specifications



ECO SMART - HYPER INVERTER (R32) - COOLING ONLY

MODEL	Unit	SRK13YXS-W6	SRK18YXS2-W6	SRK24YVS-W6	
	Indoor Unit	SRK13YXS-W6	SRK18YXS2-W6	SRK24YVS-W6	
	Outdoor Unit	SRC13YXS-W6	SRC18YXS2-W6	SRC24YVS-W6	
Ton - Cooling Only	(minimum ~maximum)	1.1 (0.25 Ton ~ 1.25 Ton)	1.65 (0.48 Ton ~ 1.96 Ton)	2.2 (0.65 Ton ~ 2.36 Ton)	
BEE Star Rating - 2024		5 Star	5 Star	5 Star	
Super Tropical Compressor Type		Rotary	Rotary	Twin Rotary	
VFD - Variable Frequency Drive		Inverter Vector Control Technology for Higher Efficiency			
Minimum Compressor RPM		7 ~ 15 RPM - Using Vector Control Technology			
Refrigerant Volume Control Using		Motorized Electronic Expansion Valve for Variable Refrigerant Flow			
LCD Remote Control (iPM Controller)		iPM (Intelligent Power Module)			
Power Source		1 Phase, 220 / 230 V , 50 Hz			
Maximum Cooling Capacity	120% Load	15013	23542	28320	
Rated Cooling Capacity at	100% Load	13000	19875	26272	
Rated Cooling Capacity at	50% Load	6517	9997	13477	
Maximum Cooling Capacity	120% Load	4400	6900	8300	
Rated Cooling Capacity at	100% Load	3810	5825	7700	
Rated Cooling Capacity at	50% Load	1910	2930	3950	
Rated Power Consumption at	100% Load	1000	1320	1800	
Rated Power Consumption at	50% Load	332	470	690	
Rated EER	100% Load	3.8	4.4	4.3	
Rated EER	50% Load	5.8	6.2	5.7	
Rated Indian Seasonal Energy Efficiency		ISEER	5.1	5.70	5.41
Current (minimum ~maximum)**		A	0.70 ~ 4.8	1.1 ~ 6.5	1.5 ~ 8.5
Dimension (H x W x D)	Indoor Unit	mm	290 x 870 x 230	339 x 1197 x 262	339 x 1197 x 262
	Outdoor Unit	mm	540 x 645(+57) x 275	540 x 780(+62) x 290	750 x 880(+88) x 340
Net Weight	Indoor Unit	Kgs	10.0	16	15.5
	Outdoor Unit	Kgs	27	30.5	58
Cooling Coil Row	Indoor Unit	No.s	2	3	3
Air Flow	Indoor Unit	CMH	850	1434	1450
Long Reach Air Flow Upto	Indoor Unit	Meters	5.18	17	18.28
Self Diagnosis Function	Indoor Unit		Yes	Yes	Yes
Sound Level (H/M/L/Ulo)	Indoor Unit	dB	41 / 35 / 29 / 19(Ulo)	46 / 39 / 31 / Ulo:23	43 / 40 / 36 / 24 (U-low)
Louver Swing	Indoor Unit		3D + 3D AUTO		
Special Filter	Indoor Unit		Enzyme + Solar (Deodorising Filter) + Anti Bacterial - Filters		
Blower Fan	Indoor Unit		Anti - Micro Bial Fan		
DC Fan Motor Speed	Indoor Unit		Auto / Powerful / High / Medium / Low / Ulo (Silent Mode) / Dry		
Refrigerant			R32	R32	4 Point - Multi Port
Refrigerant Piping Thickness:18Gauge	Liquid Line	mm	6.35 (1/4")	6.35 (1/4")	6.35 (1/4")
	Gas Line	mm	9.52 (3/8")	12.7 (1/2")	15.88 (5/8")
Main Power Supply to	Outdoor Unit		2.5 mm ² x 3 cores (with Earthing Cable)		
Connecting wiring	B/w IDU & ODU		2.5 mm ² x 4 cores (with Earthing Cable)		
Area Coverage ***		Sq. Meters	12 ~ 15.79	18.58 ~ 26.0	27.8 ~ 41.8

Refrigerant Pipe Length

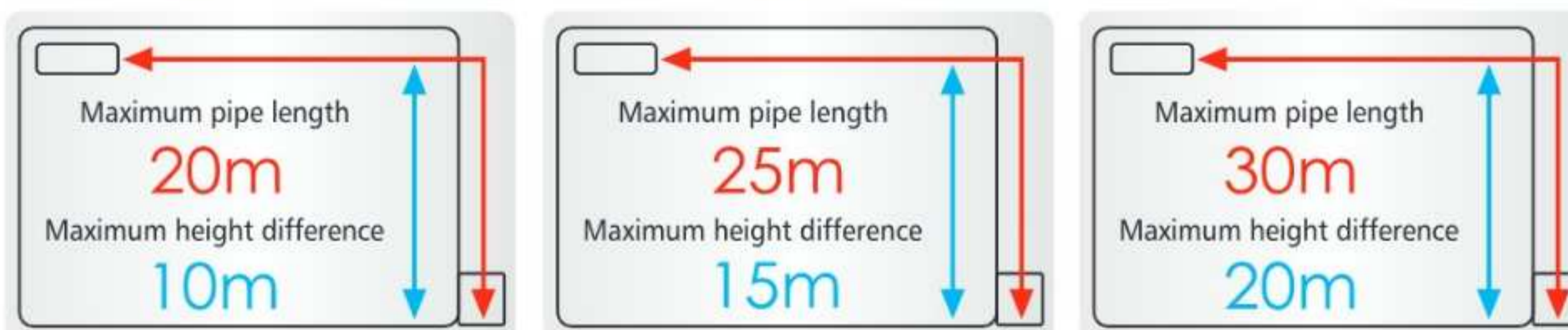

SRK13YXS-W6

SRK18YXS2-W6

SRK24YVS-W6

Remote Control



SRK13YXS-W6 /
SRK18YXS2-W6 /
SRK24YVS-W6

** Under Standard Installation & Lab Test Condition

*** Customers need to seek guidance from the Authorized Dealer / Expert for the AC unit capacity selection before ordering any AC unit. Area coverage is subject to checking of the site conditions like - Terrace / Wall / Glass windows exposed to direct sunlight, of the area to be Air- conditioned & room temperature requirement & outdoor temperature conditions. Company will not be responsible if there will be cooling issues due to improper selection of capacity of the AC units.

ISEER = INDIAN SEASONAL ENERGY EFFICIENCY RATIO

Hyper Inverter With Clean AIR Cooling Only

TURBOJET
ターボジェット
YYM Series

NEW

Features

Comfortable Air Flow Functions



Comfortable Function



Convenient & Economy Functions



Maintenance



Clean Air



Others



SRK 18YYM-W6 1.6 (0.37 Ton ~ 1.68 Ton)
SRK 24YYM-W6 2.1 (0.37 Ton ~ 2.2 Ton)



SRK 13YYM-W6 1.0 (0.25 Ton ~ 1.1 Ton)



Nano Air Filter

It has the ability to filter the small particles (PM 2.5)
Reduce the contamination of small dust in the room.

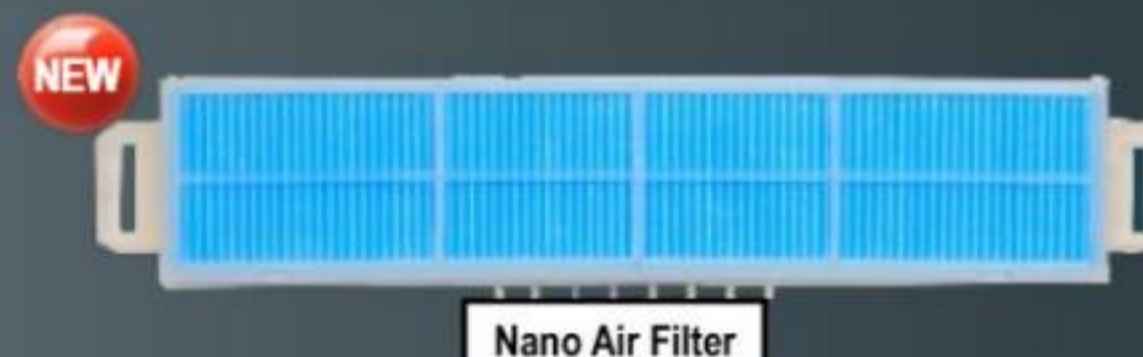

PM 2.5 Filtration



Anti Allergen Filter



Anti-Allergen + Activated Carbon



Activated Carbon Filter

Absorbs harmful gases

Combining two powers to purify the air with filter technology to stop allergens and absorb toxic gases and dust in the air.



SURROUND COOLING



WiFi - Control Function (Optional) Interface Kit

System configuration



Mobile Application



Search for "Smart M-Air" from the
GooglePlay™ store for Android™
and AppStore for iPhone.



Application compatible model: Android™ OS 8-12
smartphones and tablets, iPhone for iOS 12-15



Specifications



SPECIFICATIONS			ECO SMART - HYPER INVERTER (R32) - COOLING ONLY		
	Unit		SRK13YYM-W6	SRK18YYM-W6	SRK24YYM-W6
MODEL	Indoor Unit		SRK13YYM-W6	SRK18YYM-W6	SRK24YYM-W6
	Outdoor Unit		SRC13YYM-W6	SRC18YYM-W6	SRC24YYM-W6
Ton - Cooling Only	(minimum ~ maximum)		1.0 (0.25 Ton ~ 1.1 Ton)	1.6 (0.37Ton ~ 1.68Ton)	2.1 (0.37Ton ~ 2.2Ton)
BEE STAR RATING - 2024			3 Star	4 Star	4 Star
Super Tropical Compressor Type			Rotary	Rotary	Twin Rotary
VFD - Variable Frequency Drive			Inverter Vector Control Technology for Higher Efficiency		
Minimum Compressor RPM			7 ~ 15 RPM - Using Vector Control Technology iPM (Intelligent Power Module)		
Refrigerant Volume Control Using			Motorized Electronic Expansion Valve for Variable Refrigerant Flow		
Remote Control			LCD Remote Control		
Power Source			1 Phase, 220 / 230 V, 50 Hz		
Maximum Cooling Capacity **	BTU/hr		12795	20131	25931
Rated Cooling Capacity (100% Load)			12027	19001	25436
Rated Cooling Capacity (50% Load)			5787	8800	11567
Maximum Cooling Capacity **	Watts		3750	5900	7600
Rated Cooling Capacity (100% Load)			3525	5569	7455
Rated Cooling Capacity (50% Load)			1696	2579	3390
Rated Power Consumption (100% Full Load)	watts		1180	1602	2280
Rated Power Consumption (50% Half Load)			316	459	612
Rated EER (100% Load)	W/w		3.0	3.5	3.3
Rated EER (50% Load)			5.4	5.6	5.5
Rated Indian Seasonal Energy Efficiency Ratio	ISEER		4.39	4.84	4.67
Current (minimum ~ maximum) **	A		0.50 ~ 5.5	0.70 ~ 7.5	1 ~ 10.5
Dimension (H x W x D)	Indoor Unit	mm	294 x 798 x 198	294 x 998 x 230	294 x 998 x 230
	Outdoor Unit	mm	540 x 745 x 275	540 x 780(+62) x 290	640 x 800(+71) x 290
Weight	Indoor Unit	Kgs	9.5	11.5	11.5
	Outdoor Unit	Kgs	23.5	31.0	38.5
Cooling Coil Row	Indoor Unit	No.s	2	2	2
Air Flow	Indoor Unit	CMH	760	1100	1300
Long Reach Airflow Upto	Indoor Unit	Meters	4	12	15.25
Self Diagnosis Function	Indoor Unit		Yes	Yes	Yes
Sound Level (H/M/L/Ulo)	Indoor Unit	dB	41 / 33 / 26 / Ulo 20	43 / 35 / 27 / Ulo 21	48 / 39 / 30 / Ulo 21
Louver Swing	Indoor Unit		3D + 3D AUTO Controlled by Micro Processor		
Special Filter	Indoor Unit		Nano Filter + Anti Allergen Filter + Activated Carbon Filter		
Blower Fan	Indoor Unit		Anti - Micro Biol Fan		
DC Fan Motor Speed	Indoor Unit		Auto / Powerful / High / Medium / Low / Ulo		
Refrigerant			R32	R32	R32
Refrigerant Piping Thickness: 18Gauge (1mm)	Liquid Line	mm	6.35 (1/4")	6.35 (1/4")	6.35 (1/4")
	Gas Line	mm	9.52 (3/8")	12.7 (1/2")	12.7 (1/2")
Main Power Supply to	Outdoor Unit		2.5 mm2 x 3 cores (with Earthing Cable)		
Connecting wiring	B/w IOU & ODU		2.5 mm2 x 4 cores (with Earthing Cable)		
Area Coverage***		Sq.Meters	9.3 ~ 13	17 ~ 22.3	26 ~ 30.20

Refrigerant Pipe Length

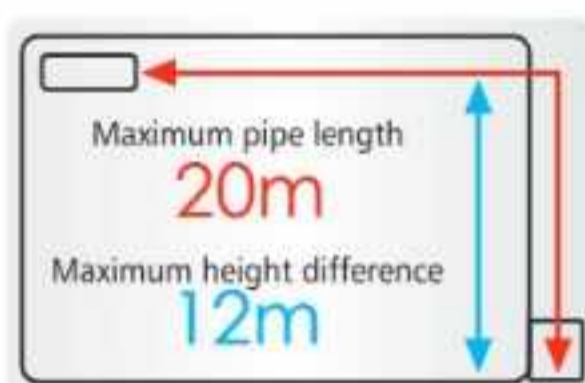

SRK13YYM-W6

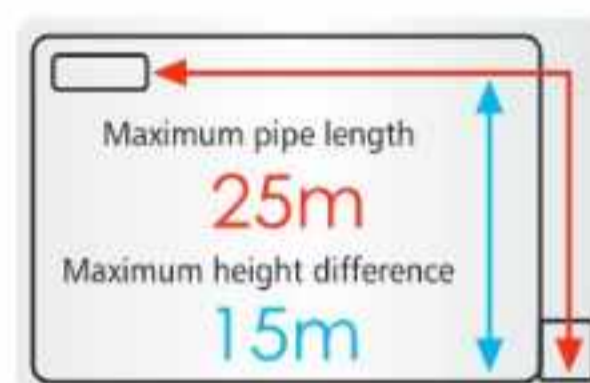

SRK18YYM-W6

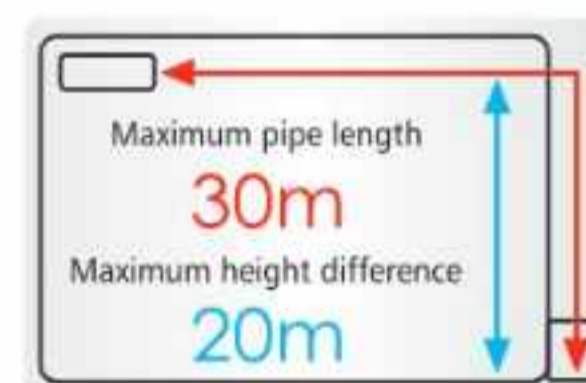

SRK24YYM-W6



SRC13YYM



SRC18YYM



SRC24YYM

Remote Control



** Under Standard Installation & Lab Test Condition

*** Customers need to seek guidance from the Authorized Dealer / Expert for the AC unit capacity selection before ordering any AC unit. Area coverage is subject to checking of the site conditions like - Terrace / Wall / Glass windows exposed to direct sunlight, of the area to be Air- conditioned & room temperature requirement & outdoor temperature conditions. Company will not be responsible if there will be cooling issues due to improper selection of capacity of the AC units.

ISEER = INDIAN SEASONAL ENERGY EFFICIENCY RATIO



Our Motto
"Customer Satisfaction Index No.-1"

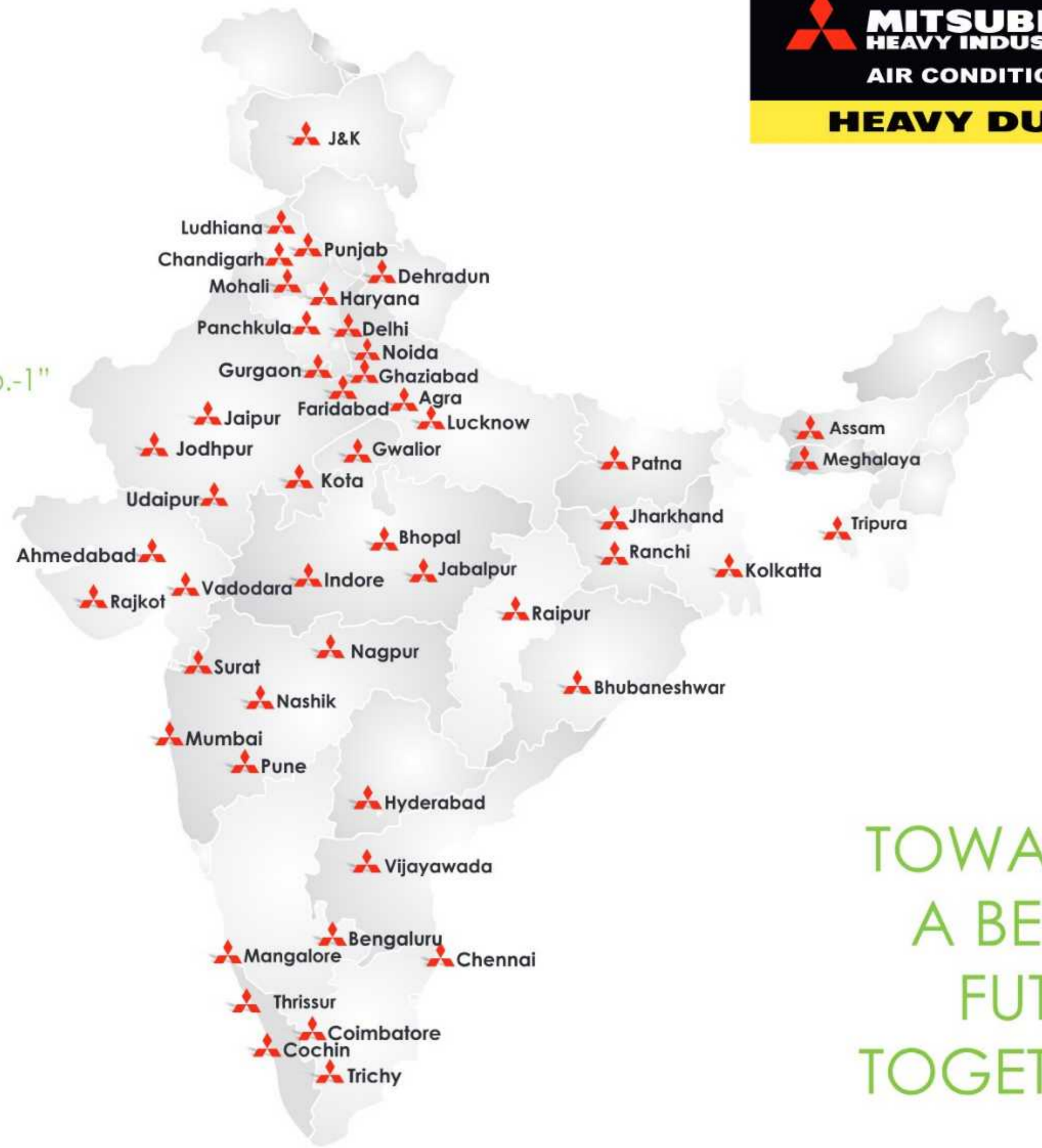

TOWARDS
A BETTER
FUTURE
TOGETHER

PRECAUTIONS

Always get the Mitsubishi Heavy Ind. Airconditioners installed by Authorized Mitsubishi Heavy Ind. Sales & Service Channel Partners only. Do not try to install the AC either by yourself or any unauthorized dealer. Improper installation can result into non performance, low cooling, refrigerant leakage, electrical shocks.

Warranty of the product shall be null & void, if not installed by an authorized Mitsubishi Heavy Ind. Sales & Service Channel Partner. In no case it will be company's responsibility if the AC unit is installed by an unauthorized dealer, is unable to perform.

Warranty of the AC unit component shall be null & void if non specified/non genuine spares are used or repaired by an unauthorized dealer.

Because of our policy of continuous improvement, we reserve the right to make changes in all specifications without notice.

In case of any adverse area to be conditioned, if it is not verified by the company/dealer engineer and selection of the AC unit is made by the customer based on the specifications without taking any prior advice, then company will not be responsible for any variance in the performance of the AC unit installed.

Mitsubishi Heavy Industries- Mahajak Air Conditioners Co.Ltd. Lat krabang Industries Estate, Phase 3, 200 Moo 4, Chalongkrung Road, Lamplatiw, Lat krabang, Bangkok Thailand 10520

Sales, Service & Marketing Headquarter (India)



IAPL House, 2/8, West Patel Nagar
Near Patel Nagar Metro Station- New Delhi- 110008 (INDIA)
Tel.: 011-47230000-99, Toll Free No.: 1800 102 0055
Email: info@iaplgroup.com, Website: www.iaplgroup.com

AGRA : 7290094940/8006003003, AHMEDABAD : 9978991675, ASSAM : 8420768025, BANGALORE : 9849102323, BIHAR : 8588864471, BHOPAL : 9630098716, BHUBANESWAR : 8697706531, CHENNAI : 8939991872, COCHIN : 9946446067, COIMBATORE : 9811889006, DEHRADUN : 8826899163, DELHI & NCR : 8826392381, DELHI : 8826392374, GHAZIABAD : 8826899163, GWALIOR : 9630098716, HARYANA : 7290094933 / 8929602345, HYDRABAD : 9849102323, INDORE : 9630033341, J & K : 9915009212 / 9599656801, JABALPUR : 9630098716, JAIPUR : 8588830502/9711939345, JHARKHAND : 6290824780, JODHPUR : 9636992277, KOLKATA : 8697744670, LUCKNOW : 8929602483, LUDHIANA : 8283843670 / 9599656893, MUMBAI : 8879599905, MEGHALAYA : 8420768025, NAGPUR : 9657004567, NASIK : 7291972089, NOIDA : 8826899163, PATNA : 8588864471, PUNE : 7291972089, PUNJAB : 9915009212 / 9599656801, RAIPUR : 9821197915, RAJKOT : 9727731456, SURAT : 9979025320, THRISSUR : 9946446067, TRICHY : 9811889006, TRIPURA : 8420768025, UDAIPUR : 9636992211, VADODARA : 9978991675, VIJAYAWADA : 9550488000.



(Wholly-owned subsidiary of MITSUBISHI HEAVY INDUSTRIES, LTD.)



Our factories are ISO9001 and ISO14001 certified.

Certified ISO 9001

Certified ISO 14001



BIWAJIMA PLANT
Mitsubishi Heavy Industries, Ltd.
Air-conditioning & Refrigeration Systems Headquarters
Certificate number: JQA3708

BIWAJIMA PLANT
Mitsubishi Heavy Industries, Ltd.
Air-conditioning & Refrigeration Systems Headquarters
Certificate number: JQA3708

MITSUBISHI HEAVY INDUSTRIES-
MAHAJAK AIR CONDITIONERS CO., LTD.
Certificate Number: 04100-104-013

MITSUBISHI HEAVY INDUSTRIES-
MAHAJAK AIR CONDITIONERS CO., LTD.
Certificate Number: 04104-104-013